

[See all 15 Products in Family](#)

## T-Thread Mounting Ring for Motorized Filter Wheel



#59-772: T-Thread Mounting Ring for Motorized Filter Wheel

Stock **#59-772** **2 In Stock**

1 MRP ₹10,796

Price inclusive of all taxes

**ADD TO CART**

### Volume Pricing

Qty 1+	₹10,796 each
Need More?	<a href="#">Request Quote</a>

### Product Downloads

### Regulatory Compliance

**Compliant** RoHS 2015:

**Compliant** Reach 224:

**View** Certificate of Conformance:

United States Country of Origin:

**Imported By:**

Edmund Optics India Private Limited  
267, Greystone Building, Second Floor,  
6th Cross Rd, Binnamangala,  
Stage 1, Indiranagar, Bengaluru,  
Karnataka, India 560038  
Phone: +91- 80-6845 0000

## Product Details

- USB or RS-232 Interface
- Bi-Directional Movement
- C-Mount and T-Mount Adapters Available

These Motorized Filter Wheels are ideal for a number of automated applications requiring spectral selection or light intensity control. The RS-232 filter wheel can be controlled directly via a control box, or remotely using an RS-232 interface. The USB filter wheel requires a PC connection for motorized operation. Both Motorized Filter Wheels include a Windows®-based graphical user interface, filter wheel housing with integrated stepper motor, USB or RS-232 cables, and 12VDC power supply.

**Note:** Filter holders are sold separately. Software and Manuals available for [download](#)

Two interchangeable filter holders are available for the Motorized Filter Wheels. The 8-position holder can accept up to eight 25mm and 1" diameter filters that are up to 5.5mm in thickness. The 5-position holder can accept up to five 50mm diameter filters that are up to 5.5mm in thickness. Each filter holder can be easily removed from the Motorized Filter Wheel without the use of tools. A hinged door is secured by a single captive thumbscrew; once opened, the filter holder can be extracted and another inserted in its place. The filter holders include an assortment of 0.75mm and 1.5mm thick spacers to accommodate different filter thicknesses. Each filter is held in place by two easily removable plastic tabs.

The filter wheel housing can be mounted using English or metric mounting plates. The English mounting plates are designed with three 1/4-20 tapped holes for post mounting, and are compatible with English laboratory tables. The metric mounting plates are designed with three M6 tapped holes for post mounting, and are compatible with metric laboratory tables. C-mount or T-mount adapters are available for easy integration.

The USB-to-serial converter allows USB connection of the RS-232 filter wheel's control box to a computer that does not have a native COM(RS-232) port.

## Technical Information

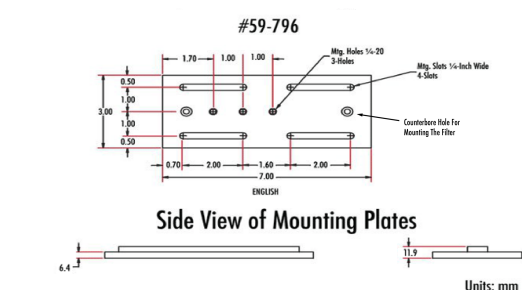
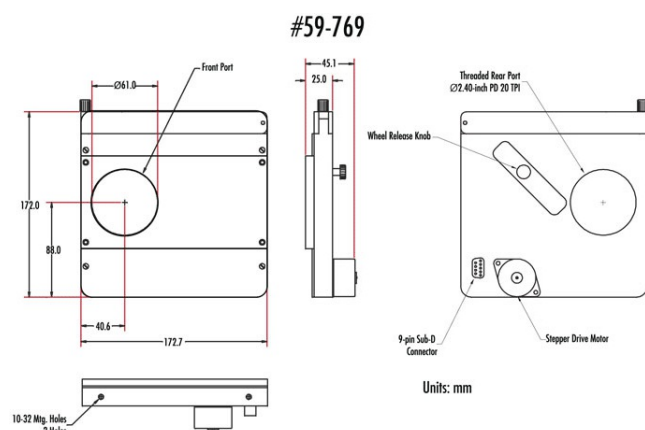
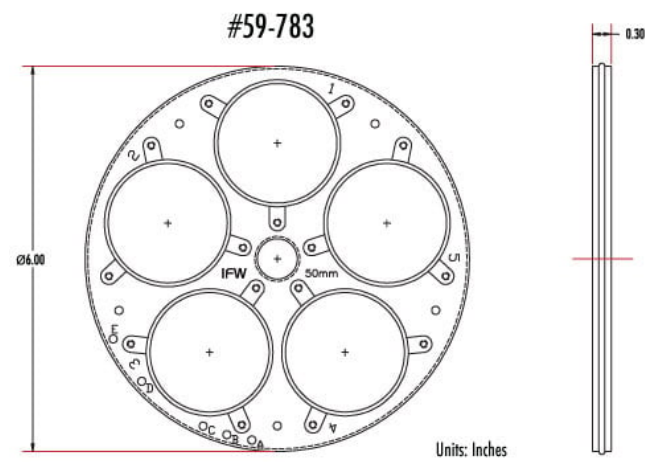
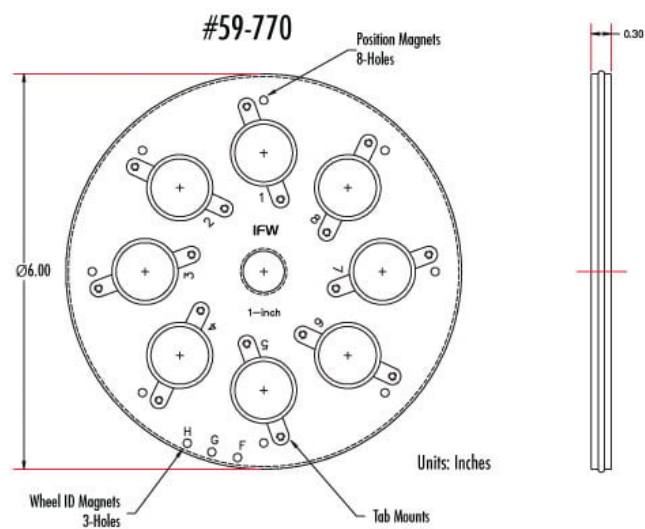

### Top View of Mounting Plates

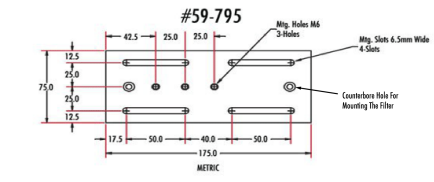

### Side View of Mounting Plates

