

[See all 10 Products in Family](#)

Objective MX-3

See More by [Infinity Photo-Optical Company](#)



#56-013 + #86-888



Stock **#56-016** [CONTACT US](#)

- 1 + MRP ₹77,526

● Price inclusive of all taxes

ADD TO CART

Volume Pricing

Qty 1+	₹77,526 each
Need More?	Request Quote

Product Downloads

General

Lens Accessory **Type:**

Sensor

2/3" **Maximum Sensor Format:**

Threading & Mounting

C-Mount

Mount:

Regulatory Compliance

Compliant

RoHS 2015:

Compliant

Reach 224:

View

Certificate of Conformance:

Country of Origin:

United States

Imported By:

Edmund Optics India Private Limited
267, Greystone Building, Second Floor,
6th Cross Rd, Binnamangala,
Stage 1, Indiranagar, Bengaluru,
Karnataka, India 560038
Phone: +91- 80-6845 0000

Product Details

- Manual Iris
- Objective Options Giving PMAG 0.58X – 2.9X
- Clamp offers 1/4-20 mounting hole
- Optional **LDL** Tubes Double Magnification
- Requires the Use of an MX Objective

InfiniMax™ is the newest addition to Infinity Photo-Optical's line of imaging lenses designed specifically for machine vision applications. Using a patented internal focusing system, the InfiniMax™ is able to provide constant magnification over a working distance range. (Using MX-3 through MX-6 objectives only. Working distance range varies by objective.) The MX-1 and MX-2 provide fields of view on the order of 10mm at distances over 10" away, but do not provide constant magnification over the working distance range. The included variable iris diaphragm can be used to adjust light intensity and increase depth of field. Interchangeable objectives thread onto main body. **LDL** and **LFA** adapters connect directly to C-Mount. LFA provides coverage for large format cameras (F-Mount adapter included, 24 x 36mm max sensor).

Note: The InfiniMax® requires the use of an MX objective below.

Technical Information

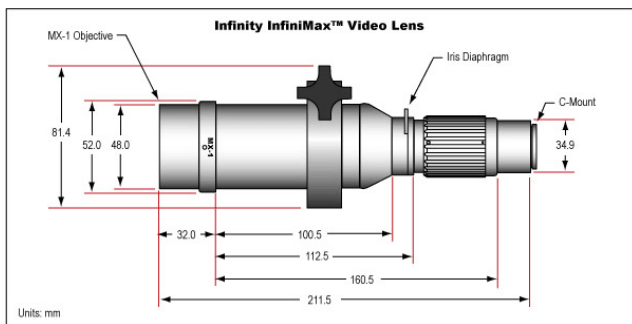

Objective	MX-1	MX-2	MX-3	MX-4	MX-5	MX-6
Primary Magnification	0.58 - 0.64X	0.78 - 0.81X	1.00X	1.16X	1.42X	2.90X
Field of View (1/2" Sensor Horiz.)	11.1 - 10.1mm	8.2 - 7.9mm	6.4mm	5.5mm	4.5mm	2.2mm
Working Distance	381 - 315mm	285 - 250mm	194 - 174mm	181 - 164mm	146 - 134mm	68 - 65mm
Size (Max Diameter x L)	52 x 32mm	52 x 32mm	52 x 64mm	52 x 32mm	52 x 32mm	52 x 26.2mm