

[See all 29 Products in Family](#)

TECHSPEC® Mounting Clamp, 240mm Bolt Circle Diameter

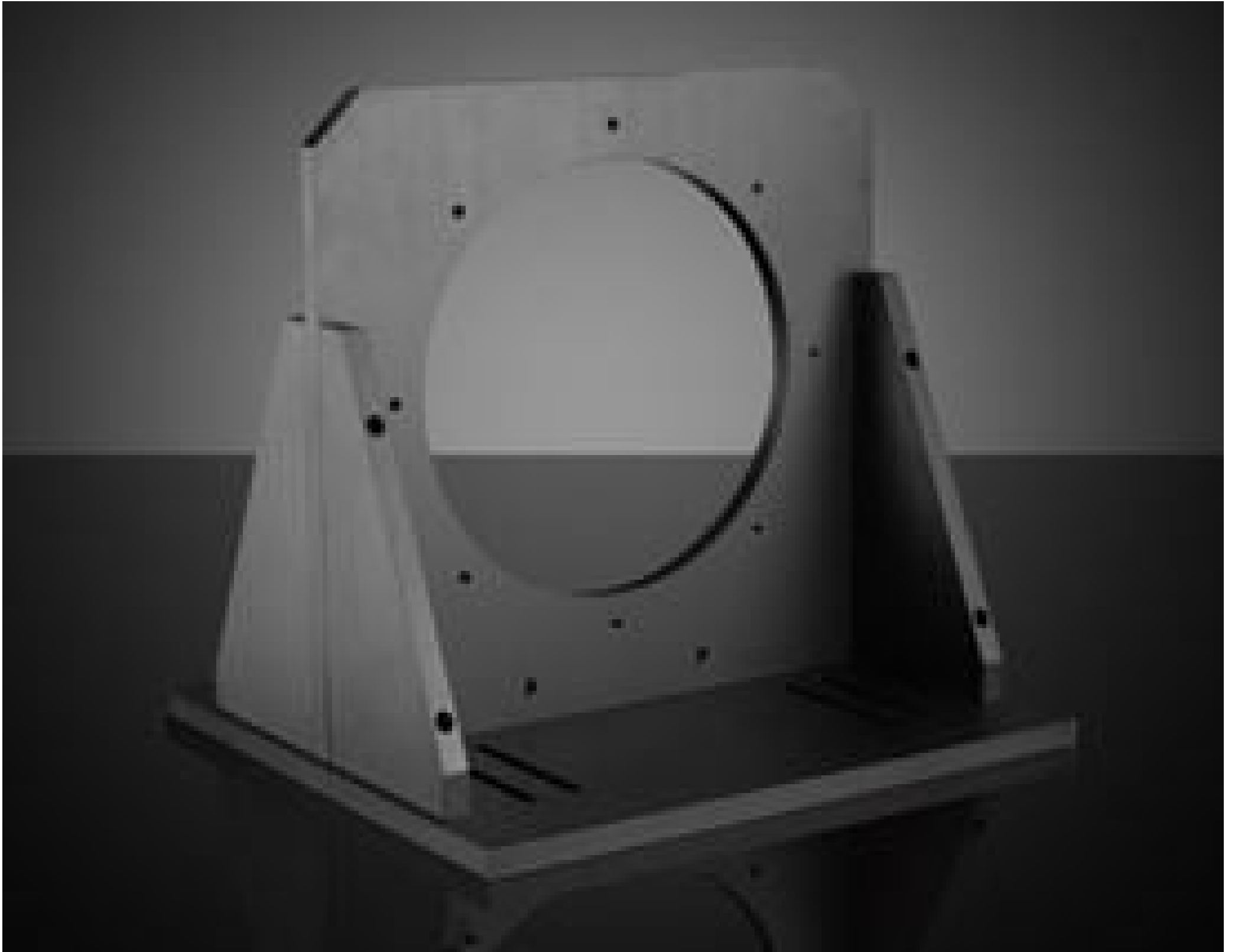

Image shows 28-641



Stock **#28-641** [CONTACT US](#)

⊖ 1 ⊕ MRP ₹1,09,917

📌 Price inclusive of all taxes

ADD TO CART

Volume Pricing	
Qty 1+	₹1,09,917 each
Need More?	Request Quote

Product Downloads

General

Note:
Includes mounting hardware and ball drivers

Physical & Mechanical Properties

240 **Inner Diameter (mm):**

Construction:

173.1 Centerline Height (mm):

Regulatory Compliance

[View](#) Certificate of Conformance:

China Country of Origin:

Imported By:
 Edmund Optics India Private Limited
 267, Greystone Building, Second Floor,
 6th Cross Rd, Binnamangala,
 Stage 1, Indiranagar, Bengaluru,
 Karnataka, India 560038
 Phone: +91- 80-6845 0000

Product Details

- Large Field of View Telecentric Lens
- Up to 31.4 MegaPixels, 3.45µm Pixel Size Sensors
- Full Frame (35mm), C-Mount, T-Mount, M58-Mount, F-Mount Telecentric Lens
- Magnification from 0.037X to 0.377X

TECHSPEC® TitanTL® Telecentric Lenses are designed for machine vision systems and metrology applications that require a large field of view. These lenses feature large maximum sensor formats, a variety of working distance and magnification options, and a rear filter holder on the back of the lenses to allow for easy filter integration. On our 118mm, 182mm and 242mm FOV versions, the integrated mounting flange allows for ease of securing each lens without requiring an additional mount and provides an easy to locate reference plane. TECHSPEC® TitanTL® Telecentric Lenses contain shims that provide adjustment for variation in camera sensor location, an adjustable iris and a 3 set screw lens mount for simple rotational alignment to the camera. Typical applications include automotive and electronic inspection, measurement and gauging applications.

These lenses won the [Silver Level 2017 Innovators Award](#).

Note: Detailed inspection reports included with each lens.

Technical Information

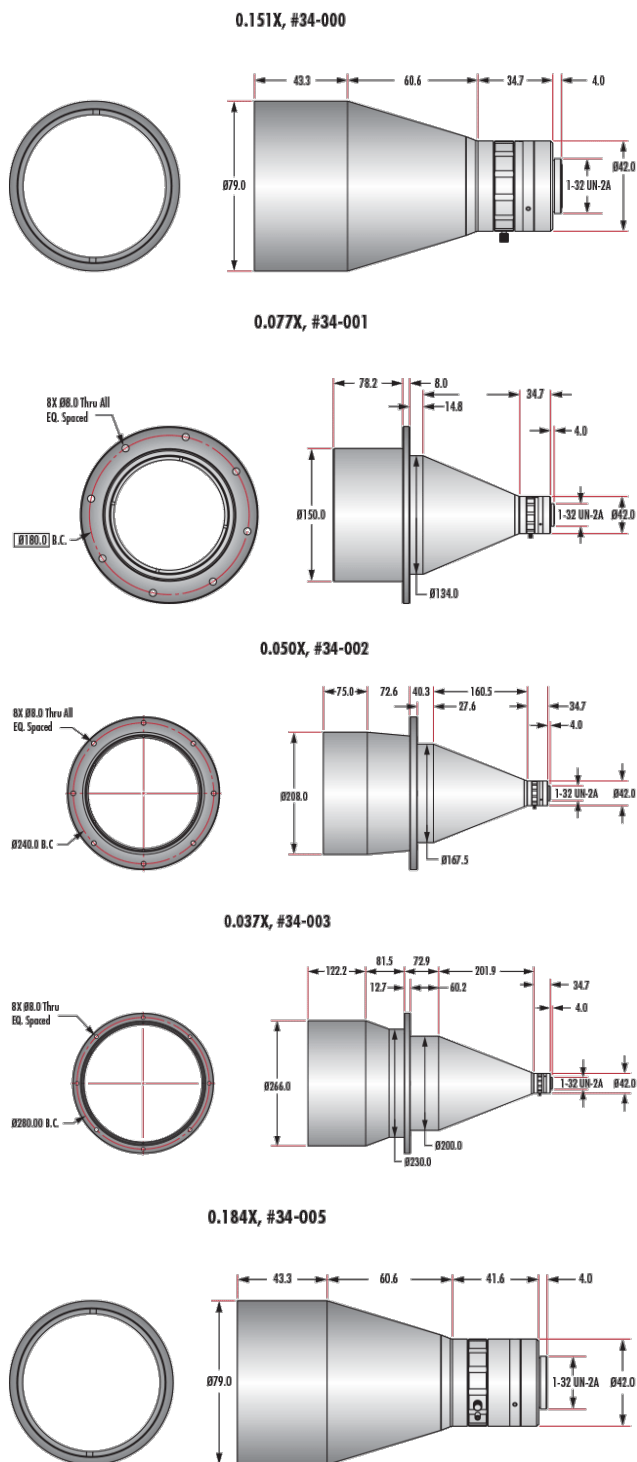

0.093X, #34-006

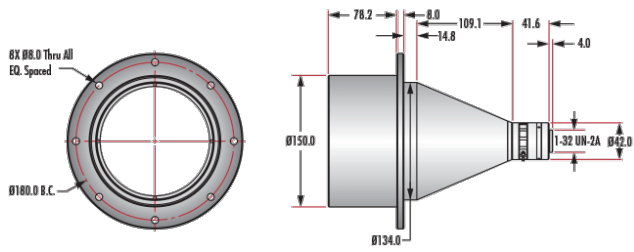

0.060X, #34-007

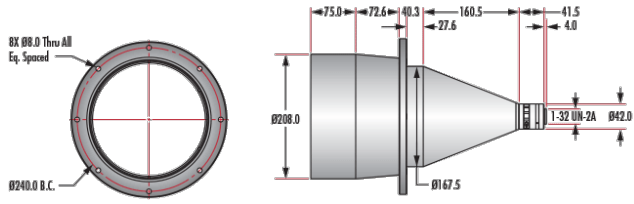

0.045X, #34-008

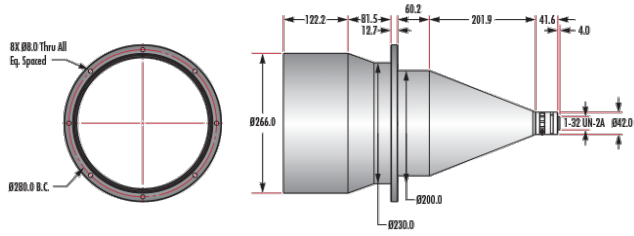

0.268X, #34-010

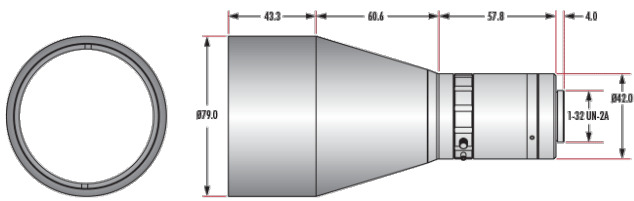

0.136X, #34-011

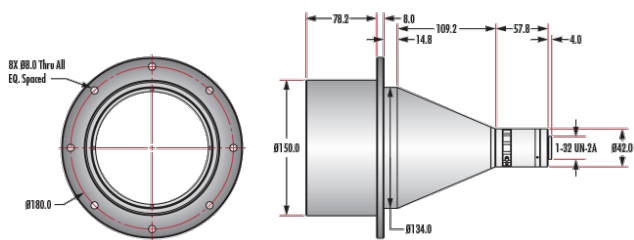

0.088X, #34-012

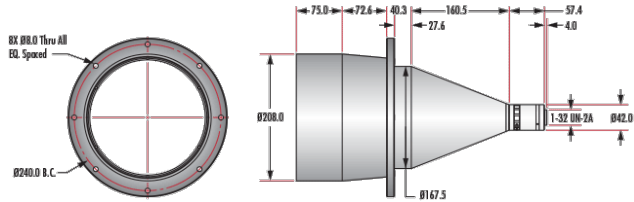

0.066X, #34-013

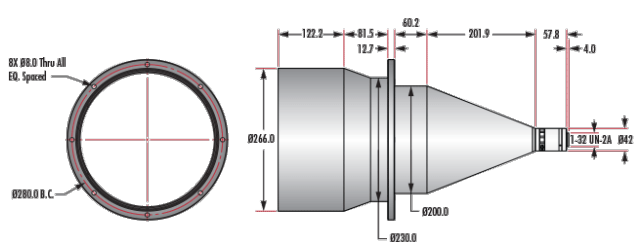

0.377X, #34-015

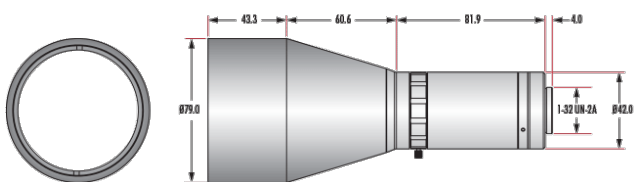

0.191X, #34-016

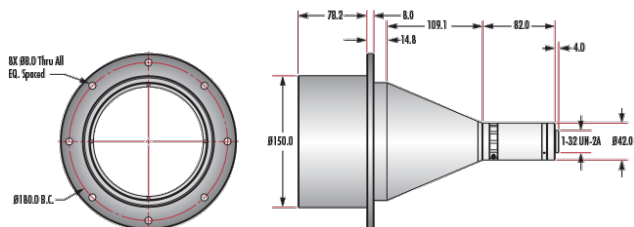

0.124X, #34-017

