

TECHSPEC® C-Mount Achromat Pair 1:1 with 75 and 75mm Focal Lengths



Stock #87-190 [CONTACT US](#)

- 1 + MRP ₹44,090

Price inclusive of all taxes

ADD TO CART

Volume Pricing	
Qty 1-5	₹44,090 each
Qty 6-25	₹35,312 each
Qty 26-49	₹34,101 each
Need More?	Request Quote

Product Downloads

General

Relay Lens **Type:**

Physical & Mechanical Properties

0.8 - 20 **Aperture (mm):**

38.00 **Housing Diameter (mm):**

Housing Length (mm):

45.9

Image Distance (mm):

60.00

Optical Properties

Surface Quality:

40-20

Working f#:

f/3.7 - f/94

Coating:

VIS 0° (425-675nm)

Coating Specification:

$R_{avg} \leq 0.4\%$ @ 425 - 675nm

Effective Focal Length EFL A (mm):

75.0

Effective Focal Length EFL B (mm):

75.0

Magnification:

1:1

Object Distance (mm):

60.00

Wavelength Range (nm):

425 - 675

Regulatory Compliance

Certificate of Conformance:

[View](#)

Country of Origin:

United States

Imported By:

Edmund Optics India Private Limited
267, Greystone Building, Second Floor,
6th Cross Rd, Binnamangala,
Stage 1, Indiranagar, Bengaluru,
Karnataka, India 560038
Phone: +91- 80-6845 0000

Product Details

- C-Mount Designs for Easy Integration into Imaging Applications
- Feature Integrated Iris for Increased Control of Light Throughput
- Ideal for Relay or Projection Applications

TECHSPEC® C-Mount Achromatic Pairs are designed to be easily integrated into a variety of OEM applications. TECHSPEC C-Mount Achromatic Pairs utilize an integrated iris to allow for user adjustment of numerical aperture and depth of focus. Each lens has been oriented for maximum system performance. The aluminum housing removes the risks associated with handling loose optics. Broadband visible coated lenses provide high transmission and low reflection loss over wide spectral regions.

Technical Information

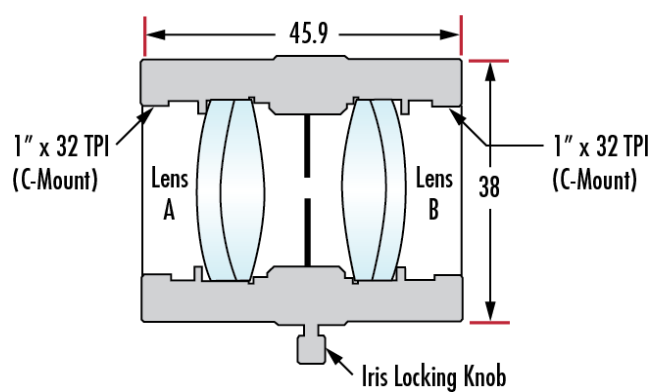

Coating Curves