

6" Shaft for Articulating Arm



Stock #53-889 **20+ In Stock**

- 1 + MRP ₹2,976

Price inclusive of all taxes

ADD TO CART

Volume Pricing

Qty 1-9	₹2,976 each
Qty 10+	₹2,683 each
Need More?	Request Quote

Product Downloads

General

English **Type:**

6" Shaft **Note:**

(1) 6" **Shafts:**

Physical & Mechanical Properties

Construction:

Regulatory Compliance

Compliant **RoHS 2015:**

View **Certificate of Conformance:**

United States **Country of Origin:**

Imported By:
 Edmund Optics India Private Limited
 267, Greystone Building, Second Floor,
 6th Cross Rd, Binnamangala,
 Stage 1, Indiranagar, Bengaluru,
 Karnataka, India 560038
 Phone: +91-80-6845 0000

Product Details

- Mount and Set in Unique Orientations
- Mix and Match for Custom Mounting Combinations
- Lockable Angular Positioning

Articulating Arm Mounting Systems are designed to reach into areas not easily accessible with standard 1/4-20 mounting. These "arms" can be positioned in any angular setting (180°) via the ball-pivot assembly. A total 360° rotation can be achieved by tilting/turning the knuckle about the shaft. The position can be locked with the easily handled knob or the tamper-resistant set screw (Allen Key included). Articulating Arm Mounting Systems can be used for applications ranging from mounting optical assemblies to fixturing cameras. Individual components are available, as well as One-Arm and Two-Arm packages. The One-Arm package includes two knuckles and one shaft, and the Extended One-arm package includes three knuckles and two shafts for added reach and range. Our Two-Arm package includes four knuckles and two shafts for separate arm requirements, such as alignment of dual branch fiber optic light guides. Nylon washers are provided with knuckles to avoid scratching anodized surfaces. Additional [optical bench hardware set screws](#) (not included) are available.

Technical Information

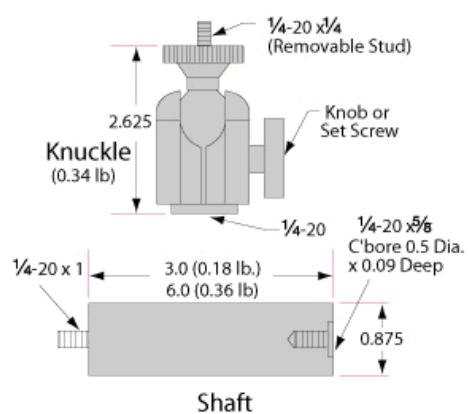

Units: Inches