

[See all 10 Products in Family](#)

5X ZEISS A-Plan Objective

See More by [ZEISS](#)



ZEISS A-Plan Objectives



Stock #13-815 **4 In Stock**

1 MRP ₹42,374

Price inclusive of all taxes

ADD TO CART

Volume Pricing	
Qty 1+	₹42,374 each
Need More?	Request Quote

Product Downloads

General

421030-9900-000 **Model Number:**

Compatible Tube Lens Focal Length (mm):
Focal Length: 164.50mm

Microscope Objective **Type:**

Fluorescence, BrightField
Typical Applications:

InfinityCorrected
Style:

Zeiss
Manufacturer:

Physical & Mechanical Properties

4.6
Field of View (mm):

34.80
Length excluding Threads (mm):

30
Maximum Diameter (mm):

143
Weight (g):

Optical Properties

0.17
Compatible Cover Glass Thickness (mm):

33.00
Focal Length FL (mm):

5X
Magnification:

0.12
Numerical Aperture NA:

2.3
Resolving Power (µm):

19.10
Depth of Field (µm):

10.1
Working Distance (mm):

480 - 650
Wavelength Range (nm):

23
Field Number (mm):

45.06
Parfocal Length (mm):

N/A
Immersion Liquid:

Threading & Mounting

M27 x 0.75
Mounting Threads:

Environmental & Durability Factors

+10 to +40
Operating Temperature (°C):

75% at 35°C
Operating Humidity:

Regulatory Compliance

[View](#)
Certificate of Conformance:

China
Country of Origin:

Edmund Optics India Private Limited
267, Greystone Building, Second Floor,
6th Cross Rd, Binnamangala,
Stage 1, Indiranagar, Bengaluru,
Karnataka, India 560038
Phone: +91- 80-6845 0000
Imported By:

Product Details

- Ideal for Brightfield and Fluorescence Applications
- Excellent Color Correction and Flatness of Field
- Oil Immersion Options Available

ZEISS A-Plan Infinity Corrected Objectives are designed for a variety of routine life science applications. These objectives exhibit excellent color correction and flatness of field that satisfy ISO 19012-1:2013 standards. They are ideal for brightfield inspection of fixed and stained tissues or cells in fluorescence applications. The large field number of 23mm facilitates fast screening of samples. ZEISS A-Plan Infinity Corrected Objectives are corrected for standard cover slips with 0.17mm thickness.

Note: Tube Lens [#13-828](#) is required when using ZEISS A-Plan Infinity Corrected Objectives with non-ZEISS Infinity Color Corrected (ICS) microscope systems.

Technical Information

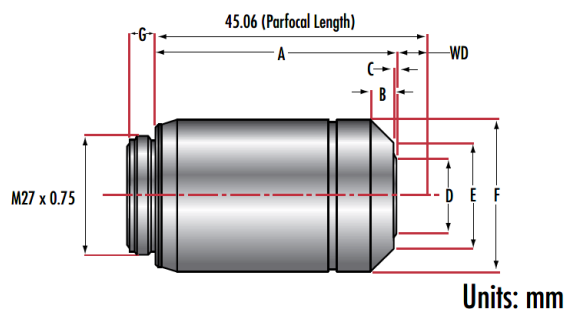

Stock No.	A-Plan	A	B	C	D	E	F	G	W.D.	PFL	Mounting Threads
#13-814	2.5X	34.5	6.25	2.75	17.0	22.5	30.0	3.9	10.40	45.06	M27x0.75
#13-815	5X	34.8	7.25	2.75	17.0	22.5	30.0	3.9	10.10	45.06	M27x0.75
#13-816	10X	40.4	4.75	5.25	12.0	22.5	30.0	3.9	4.50	45.06	M27x0.75
#13-817	20X	44.4	7.90	6.30	6.4	22.0	30.0	4.0	0.46	45.06	M27x0.75
#13-818	40X	44.4	8.00	3.30	7.0	21.0	30.0	4.0	0.45	45.06	M27x0.75
#13-819	63X	44.6	8.00	6.60	7.0	22.0	30.0	4.0	0.30	45.06	M27x0.75
#13-820	100X	43.9	10.70	3.20	7.1	19.0	30.0	3.9	0.97	45.06	M27x0.75
#13-821	100X OIL	44.7	9.00	5.70	7.0	19.0	30.0	4.0	0.22	45.06	M27x0.75