

[See all 76 Products in Family](#)

**TECHSPEC® 3.5mm, f/11 Ci Series Fixed Focal Length Lens**



3.5mm Focal Length

Stock **#87-550** **1 In Stock**

MRP ₹25,185

**Price inclusive of all taxes**

**ADD TO CART**

Volume Pricing	
Qty 1-24	₹25,185 each
Qty 25+	₹22,796 each
Need More?	<a href="#">Request Quote</a>

Product Downloads

**General**

**Product Family:**  
 Ci Series  
**Type:**  
 Fixed Focal Length Lens

**Physical & Mechanical Properties**

**Iris Option:**  
 Fixed

39.38	Length (mm):
50	Maximum Diameter (mm):
50	Outer Diameter (mm):
97	Weight (g):
2.64	Maximum Rear Protrusion (mm):
26.50	Diameter (mm):

## Optical Properties

41.2mm - 102.8°	Horizontal Field of View @ Max Sensor Format:
Horizontal: 41.2mm - 102.3° Vertical: 26.8mm - 82.3° Diagonal: 63.5mm - 116.9°	Field of View at Max Sensor Format:
41.2mm - 102.8°	Horizontal Field of View, 1/1.8" Sensor:
29.5mm - 87.2°	Horizontal Field of View, 1/2" Sensor:
23.0mm - 74.4°	Horizontal Field of View, 1/3" Sensor:
16.3mm - 57.4°	Horizontal Field of View, 1/4" Sensor:
9.00	Maximum Image Circle (mm):
0.0104	Numerical Aperture NA, Object Side:
8 (7)	Number of Elements (Groups):
3.50	Focal Length FL (mm):
0 - ∞	Working Distance (mm):
f/11	Aperture (f/#):
425 - 675nm BBAR	Coating:
425 - 675nm BBAR	Coating Specification:
15.27	Entrance Pupil Position (mm):
18.31	Object Space Principal Plane (mm):
7.49	Image Space Principal Plane (mm):
-20.94	Maximum Distortion (%):
-15.28	Exit Pupil Position (mm):
VIS	Lens Wavelength Range:

## Sensor

1/1.8"	Maximum Sensor Format:
2.74	Pixel Size (µm):

## Threading & Mounting

M105 x 1.00 (Male)	Filter Thread:
<a href="#">#89-848 (Required)</a>	Filter Thread Adapter:
M50.0 x 0.5 (Male)	Front Thread:
C-Mount	Mount:

## Environmental & Durability Factors

	Storage Temperature (°C):
--	---------------------------

**Type of Ruggedization:**  
Industrial (Fixed Aperture with Simplified Mechanics)

## Regulatory Compliance

**Certificate of Conformance:**  
[View](#)

**Country of Origin:**  
China

**Imported By:**  
Edmund Optics India Private Limited  
267, Greystone Building, Second Floor,  
6th Cross Rd, Binnamangala,  
Stage 1, Indiranagar, Bengaluru,  
Karnataka, India 560038  
Phone: +91-80-6845 0000

## Product Details

- Up to 2/3", C-Mount Lens
- Up to 7.5 MegaPixels, 2.8µm Pixel Size Sensors
- Instrumentation (Ci) Versions of our C Series Lenses with Streamlined Mechanical Designs and Fixed Apertures
- 3.5mm to 50mm Focal Length
- **Ruggedized (Cr) Designs** Also Available

TECHSPEC® Ci Series Fixed Focal Length Lenses are a streamlined version of our C Series Fixed Focal Length Lenses. They feature the same low lens-to-lens variation and broadband anti-reflection (BBAR) coating for maximum light transmission, while offering reduced weight and size. An adjustable, lockable focus allows for setting and locking the best focus position for instrumentation integration. TECHSPEC® Ci Series Fixed Focal Length Lenses are designed specifically for volume integration into applications such as factory inspection and automation to benchtop biomedical devices. The Ci Series offers a wide range of aperture options, ensuring maximum flexibility of resolution, throughput, and depth of field.

Edmund Optics has created a family of high performance optical designs (the C Series family) and developed 6 customized optomechanical solutions targeted for specific applications. These lens sub-families utilize the same optics as the C Series lenses providing the same optical performance in a variety of optomechanical solutions to meet your application requirements:

- **C Series:** Features locking cam focus and iris adjustment and is the most adjustable version of these optical designs; they are the typical high quality machine vision lenses. Also available with a **VIS-NIR Broadband Anti-Reflection (BBAR) Coating**.
- **Ci Series:** Simplified mechanics featuring fixed apertures with compact housing. **Industrial Ruggedization** for reduced size, cost, and locked focus.
- **Cr Series:** All optics glued in place and a locking C-clamp focus ring. **Stabilized Ruggedization** for reduced pixel shift and improved focus stability.
- **Cx Series:** Modular, flexible mechanics allows lenses to be taken apart for easy integration of accessories such as liquid lenses, apertures, and more.
- **Liquid Lens Cx Series:** Designed with an integrated liquid lens for quick autofocus.
- **Cw Series:** Waterproof, designed to meet IEC **Ingress Protection** Code IPX7 and IPX9K.

## Technical Information

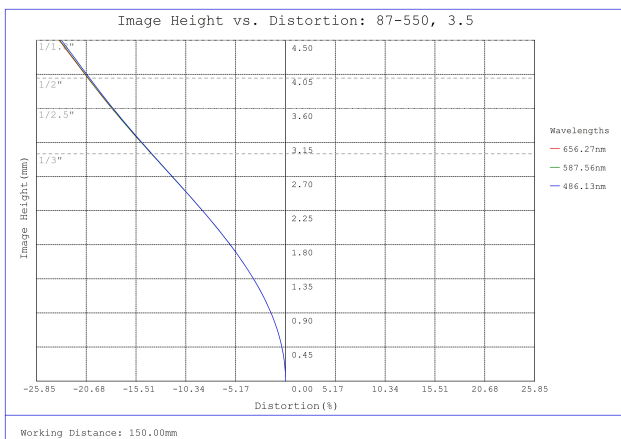

#87-550, 3.5mm, f/11 Ci Series Fixed Focal Length Lens, Distortion Plot

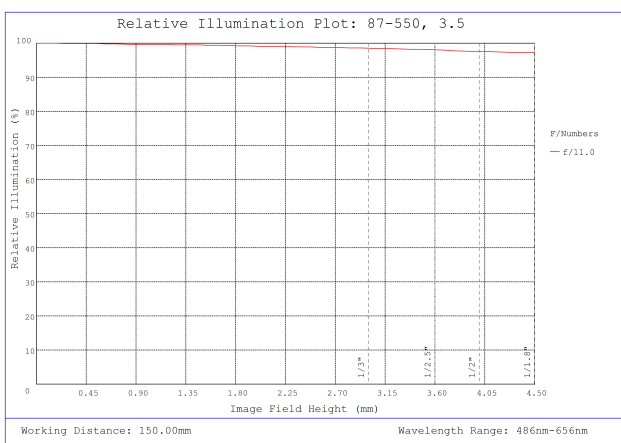

#87-550, 3.5mm, f/11 Ci Series Fixed Focal Length Lens, Relative Illumination Plot

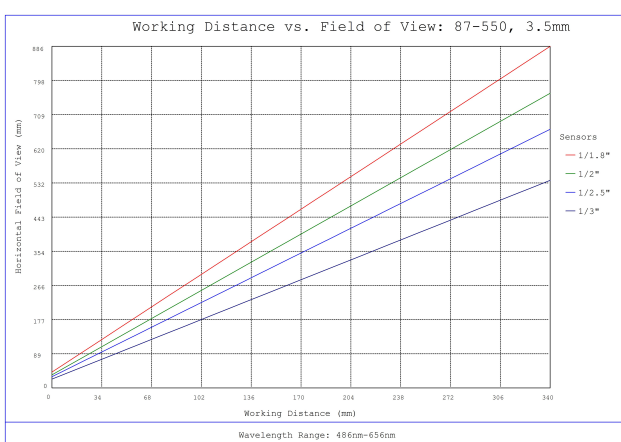

#87-550, 3.5mm, f/11 Ci Series Fixed Focal Length Lens, Working Distance versus Field of View Plot

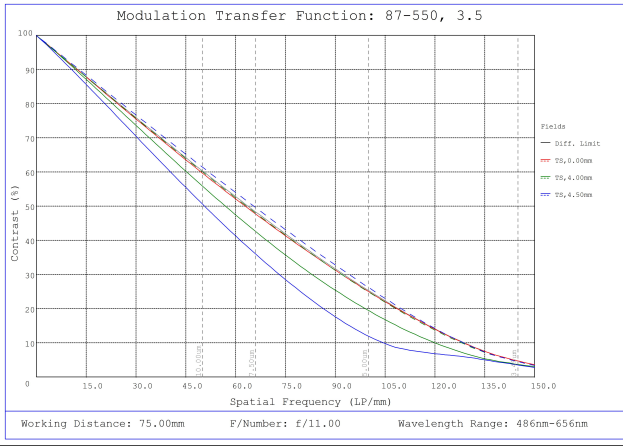

#87-550, 3.5mm, f/11 Ci Series Fixed Focal Length Lens, Modulated Transfer Function (MTF) Plot, 75mm Working Distance, f11

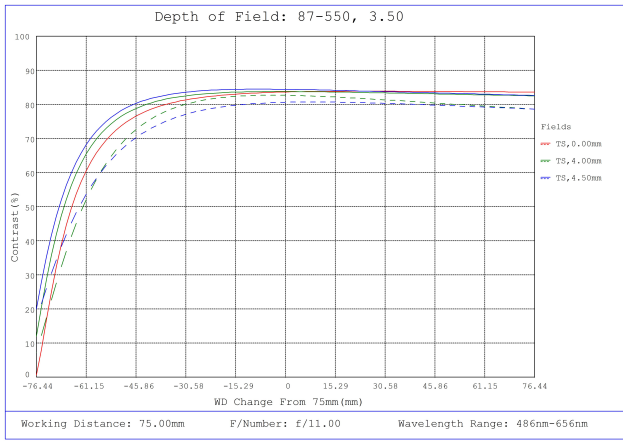

#87-550, 3.5mm, f/11 Ci Series Fixed Focal Length Lens, Depth of Field Plot, 75mm Working Distance, f11

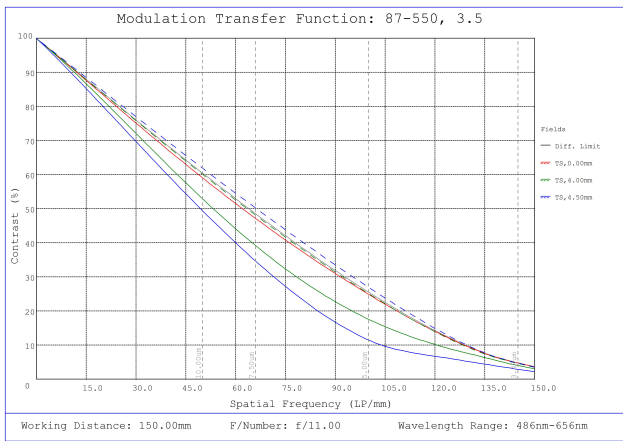

#87-550, 3.5mm, f/11 Ci Series Fixed Focal Length Lens, Modulated Transfer Function (MTF) Plot, 150mm Working Distance, f11

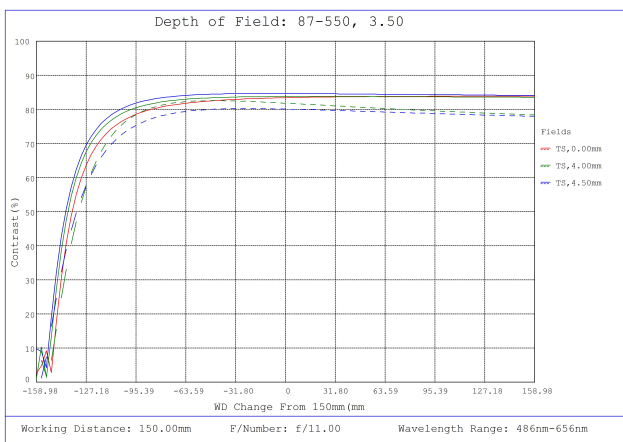

#87-550, 3.5mm, f/11 Ci Series Fixed Focal Length Lens, Depth of Field Plot, 150mm Working Distance, f11

Focal Length	A	B	C	D
6mm	M34.0 x 0.5	47.8mm	34mm	1.17mm
12mm	M22.0 x 0.75	29.0mm	22mm	0.96mm
16mm	M22.0 x 0.75	40.8mm	22mm	1.09mm
25mm	M22.0 x 0.75	29.9mm	22mm	1.33mm
35mm	M25.5 x 0.5	41mm	22.5mm	3.82mm
50mm	M30.5 x 0.5	49.5mm	30.5mm	2.06mm

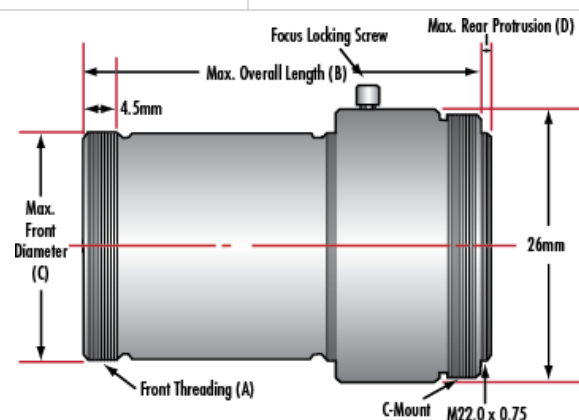

## Compatible Cameras

---