

**TECHSPEC® 25mm UV-AR Coated and Aluminized, Fused Silica Penta Prism**



Stock #49-023 CLEARANCE 17 In Stock

MRP ₹10,615

Price inclusive of all taxes

**ADD TO CART**

Volume Pricing	
Qty 1+	₹10,615 each
Need More?	<a href="#">Request Quote</a>

Product Downloads

**General**

Penta Prism Type:

**Physical & Mechanical Properties**

±0.10 Dimensional Tolerance (mm):

Protective as needed Bevel:

**Optical Properties**

UV-AR & Aluminized **Coating:**

**Fused Silica** (Coming 7980) **Substrate:**

20-10 **Surface Quality:**

±1 **Angle Tolerance (arcmin):**

Right-Handed **Image Orientation:**

**Coating Specification:**  
Entrance/Exit Faces:  $R_{abs} \leq 1.0\%$  @ 250 - 425nm,  
 $R_{avg} \leq 0.75\%$  @ 250 - 425nm,  $R_{avg} \leq 0.5\%$  @ 370 - 420nm  
Reflecting Surfaces:  $R_{avg} > 85\%$  @ 250 - 700nm  
w/Black Overpaint

90 **Ray Deviation (°):**

250 - 425 **Wavelength Range (nm):**

**Damage Threshold, By Design:**   
Entrance/Exit Faces: 3 J/cm<sup>2</sup> @ 355nm, 10ns  
Reflecting Surfaces: 0.3 J/cm<sup>2</sup> @ 532nm & 1064nm, 10ns

0.20 **Power (fringes) @ 632.8nm:**

0.20 **Irregularity (fringes) @ 632.8nm:**

## Regulatory Compliance

[View](#) **Certificate of Conformance:**

Singapore **Country of Origin:**

**Imported By:**  
Edmund Optics India Private Limited  
267, Greystone Building, Second Floor,  
6th Cross Rd, Binnamangala,  
Stage 1, Indiranagar, Bengaluru,  
Karnataka, India 560038  
Phone: +91- 80-6845 0000

## Need different specs or modifications?

Edmund Optics offers comprehensive custom manufacturing services for optical and imaging components tailored to your specific application requirements. Whether in the prototyping phase or preparing for full-scale production, we provide flexible solutions to meet your needs. Our experienced engineers are here to assist—from concept to completion.

Our capabilities include:

- Custom dimensions, materials, coatings, and more
- High-precision surface quality and flatness
- Tight tolerances and complex geometries
- Scalable production—from prototype to volume

Learn more about our [custom manufacturing capabilities](#) or submit an inquiry [here](#).

## Product Details

- Ray Deviation of 90°
- Right Handed Image
- Optical Tool for Defining a Right Angle
- Additional [Penta Prism](#) Options Available

Penta prisms are five-sided prisms featuring a ray deviation of 90° and a right handed image. The UV-AR coated options also have aluminized reflecting surfaces for increased efficiency. Slight movement of the prism does not affect the true right angle at which light rays are reflected, making a penta prism the ideal optical tool for defining a right angle in an optical system. TECHSPEC® UV Fused Silica Penta Prisms are made from UV fused silica which features low thermal expansion and excellent transmission throughout the UV, VIS, and NIR spectral ranges.

## Technical Information

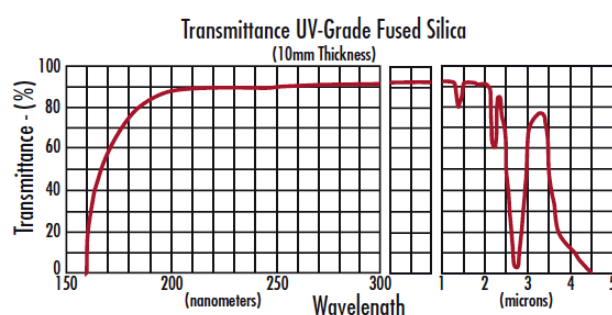

UV FS Transmission Curve

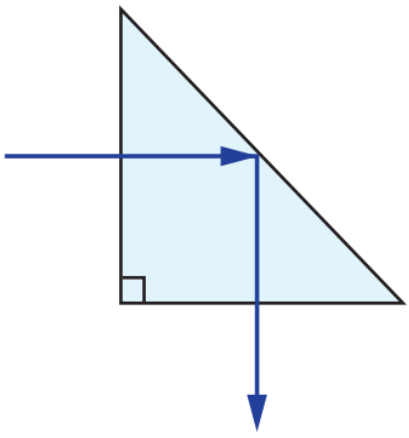

Right Angle Prism Ray Path

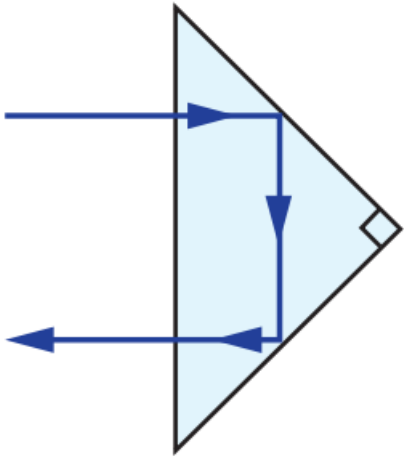

Right Angle Prism Ray Path

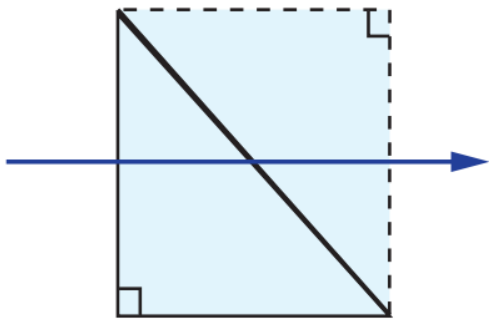

Right Angle Prism Tunnel Diagram

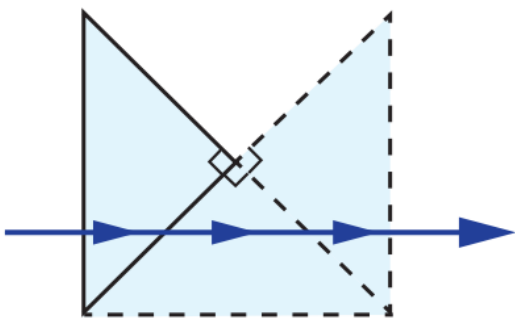

Right Angle Prism Tunnel Diagram

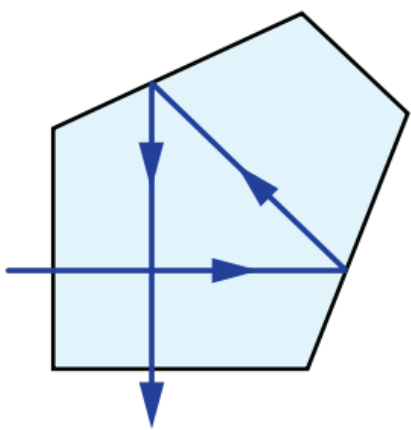

Penta Prism Ray Path

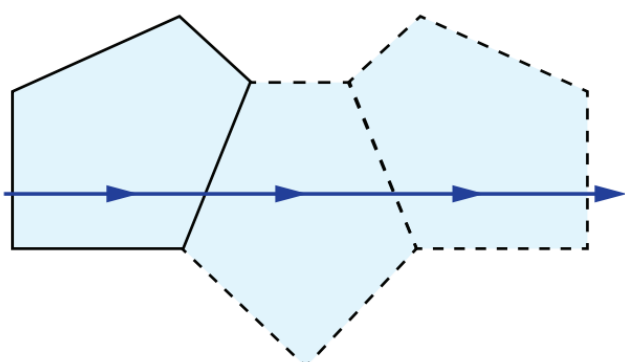

Penta Prism Tunnel Diagram

Stock No.	A	B
#49-016	5.00mm	6.10mm
#49-020		
#49-017	10.00mm	11.95mm
#49-021		
#49-018	20.00mm	21.65mm
#49-022		
#49-019	25.00mm	27.90mm
#49-023		

