

TECHSPEC® 25mm FL f/4, Blue Series M12 Lens



25mm FL Blue Series M12 Lens



Stock #69-266 **2 In Stock**

- 1 + MRP ₹9,027

! Price inclusive of all taxes

ADD TO CART

Volume Pricing	
Qty 1-49	₹9,027 each
Qty 50+	₹7,143 each
Need More?	Request Quote

Product Downloads

General

Blue Series **Product Family:**

M12 Imaging Lens **Type:**

No **IR Cut Filter:**

Imaging Lens Type:
High Performance M12 Lens

Physical & Mechanical Properties

Iris Option:
Fixed

Length (mm):
30.00

Maximum Diameter (mm):
18

Outer Diameter (mm):
18

Weight (g):
12

Optical Properties

Horizontal Field of View @ Max Sensor Format:
16.2°

Field of View at Max Sensor Format:
Horizontal: 40.0mm - 16.2°
Vertical: 26.5mm - 10.9°
Diagonal: 44.3mm - 18°

Horizontal Field of View, 1/1.8" Sensor:
40.0mm - 16.2°

Horizontal Field of View, 1/2" Sensor:
35.4mm - 14.5°

Horizontal Field of View, 1/2.5" Sensor:
32.1mm - 13.1°

Horizontal Field of View, 1/3" Sensor:
26.5mm - 10.9°

Horizontal Field of View, 1/4" Sensor:
19.9mm - 8.2°

Maximum Image Circle (mm):
9.00

Numerical Aperture NA, Object Side:
0.0205

Number of Elements (Groups):
6(5)

Wavelength Range (nm):
400 - 700

Focal Length FL (mm):
25.00

Working Distance (mm):
150 - ∞

Aperture (f#):
f/4

Distortion (%):
0.59 @ Full Field

Back Focal Length BFL (mm):
8.5 - 6.5

Coating Specification:
M4 MgF₂ @ 550nm

Entrance Pupil Position (mm):
4.15

Object Space Principal Plane (mm):
11.90

Image Space Principal Plane (mm):
-19.03

Maximum Distortion (%):
-0.59

Exit Pupil Position (mm):
-30.25

Lens Wavelength Range:
VIS

Sensor

Maximum Sensor Format:
1/1.8"

Pixel Size (μm):
1.40

Threading & Mounting

Filter Thread:
N/A

Mount:

Regulatory Compliance

Compliant **RoHS 2015:**

View **Certificate of Conformance:**

Compliant **Reach 247:**

China **Country of Origin:**

Imported By:
 Edmund Optics India Private Limited
 267, Greystone Building, Second Floor,
 6th Cross Rd, Binnamangala,
 Stage 1, Indiranagar, Bengaluru,
 Karnataka, India 560038
 Phone: +91-80-6845 0000

Product Details

- Up to 1/2", S-Mount Lens
- Up to 5 MegaPixels, 1.4µm Pixel Size Sensors
- High Resolution Board Camera Lens Optimized for Close WD
- 2mm to 35mm Focal Length
- **Ruggedized Designs** Also Available

TECHSPEC® Blue Series M12 Lenses feature high resolution performance, along with the same great versatility of our **TECHSPEC® Green Series M12 Lenses**. Each lens consists of several precision glass elements mounted in a compact, aluminum housing. These lenses can connect to C-Mount cameras using the M12 x0.5 Adapter for C-Mount Cameras (**#53-675**) or the M12 x0.5 C-Mount Adapter with Rubber O-Ring (**#59-241**) for vibration-sensitive environments. TECHSPEC® Blue Series M12 Lenses are ideal for automotive, industrial, and medical imaging application. Prescription data is available by submitting a **Request for Prescription Form**.

Note: Compatible **TECHSPEC® M12 Imaging Lens Accessories** available.

Edmund Optics has created multiple product families of our TECHSPEC® M12 S-Mount Lenses, which are designed to provide high resolution. These high performance lenses feature precision glass designs in a metal housing and have optimized specifications between each product family to meet your application needs.

- **Blue Series M12 Lenses:** High resolution finite conjugate designs optimized for machine vision working distances.
- **Rugged Blue Series M12 Lenses:** Stabilized ruggedization versions of our Blue Series M12 Lenses, utilizing the same optics.
- **Green Series M12 Lenses:** Finite conjugate designs optimized for machine vision working distances.
- **Red Series M12 Lenses:** Infinite conjugate designs optimized for high resolution performance out to infinity.
- **HEO Series M12 Lenses:** Harsh Environment Optics (HEO) sealed versions of our Red Series M12 Lenses.
- **Liquid Lens M12 Lenses:** Integrated liquid lens for fast electronic focus.

Technical Information

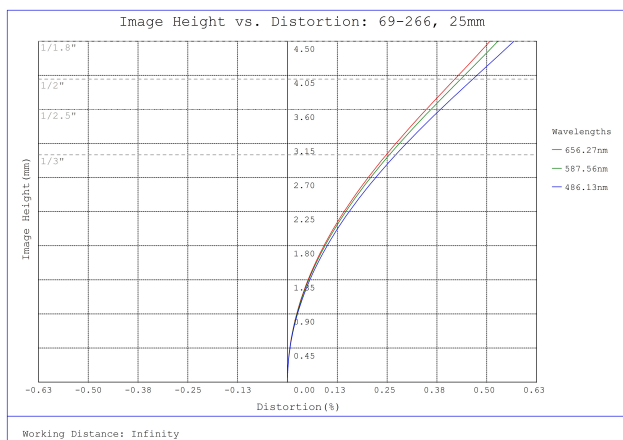

#69-266, 25mm FL f/4, Blue Series M12 Lens, Distortion Plot

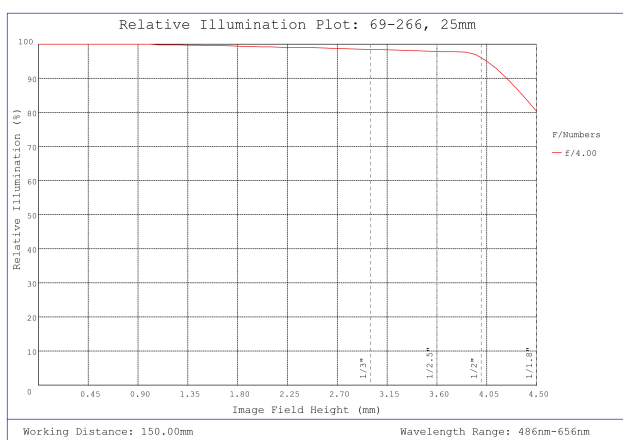

#69-266, 25mm FL f/4, Blue Series M12 Lens, Relative Illumination Plot

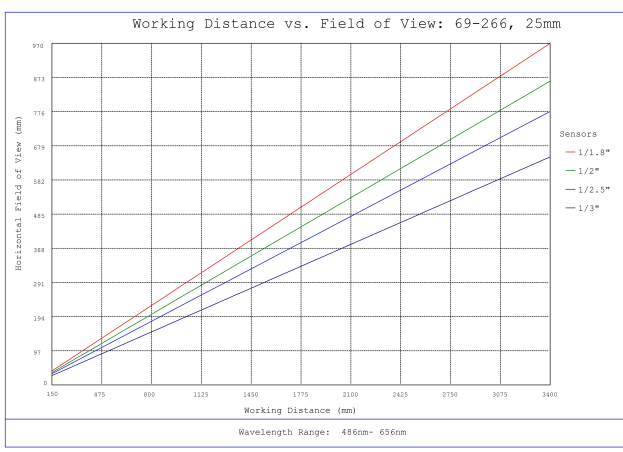

#69-266, 25mm FL f/4, Blue Series M12 Lens, Working Distance versus Field of View Plot

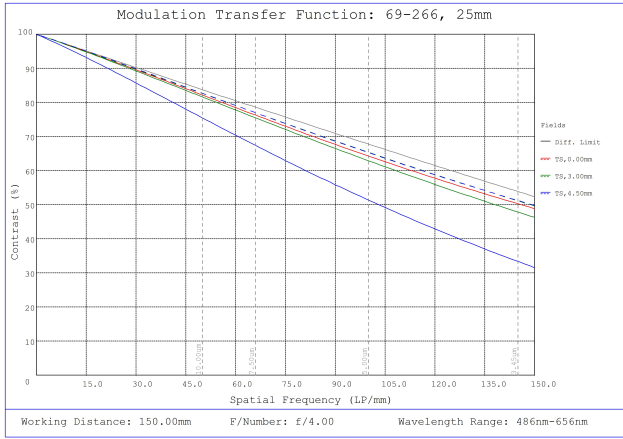

#69-266, 25mm FL f/4, Blue Series M12 Lens, Modulated Transfer Function (MTF) Plot, 150mm Working Distance, f4

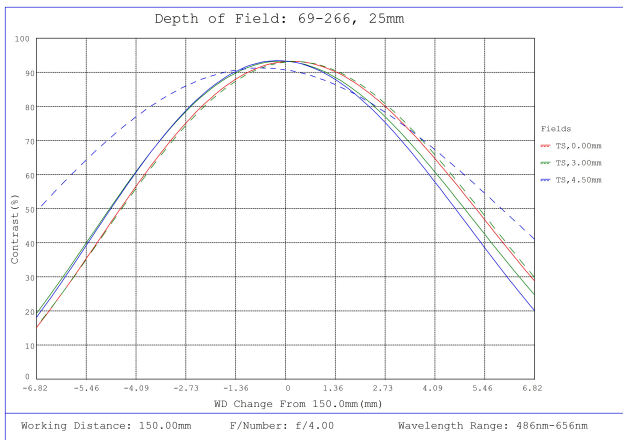

#69-266, 25mm FL f/4, Blue Series M12 Lens, Depth of Field Plot, 150mm Working Distance, f4

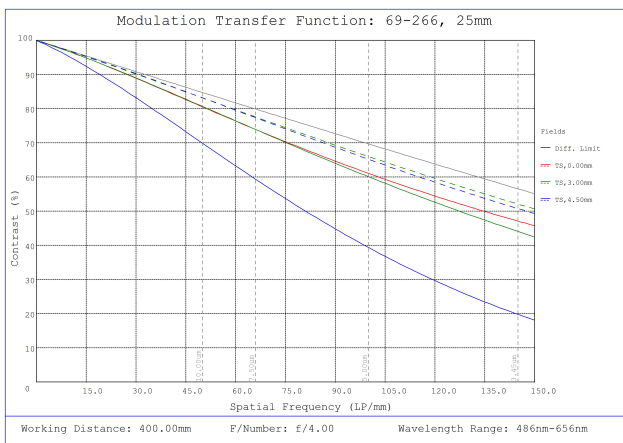

#69-266, 25mm FL f/4, Blue Series M12 Lens, Modulated Transfer Function (MTF) Plot, 400mm Working Distance, f4

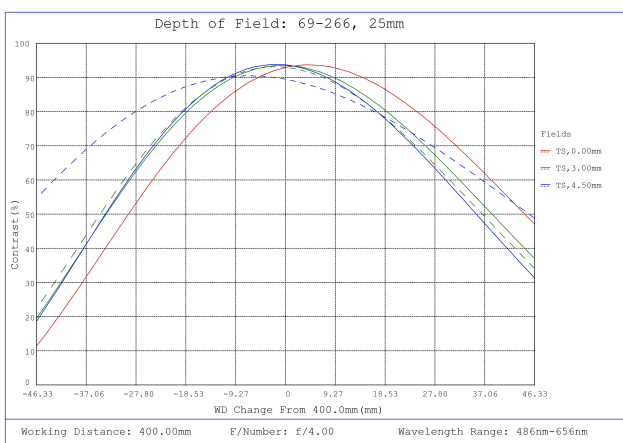

#69-266, 25mm FL f/4, Blue Series M12 Lens, Depth of Field Plot, 400mm Working Distance, f4

Focal Length	A	B	C*	D
2.0mm	18.0mm	21.7mm	2.26mm	4.75mm
3.0mm	14.0mm	17.1mm	4.8 - 4.7mm	5.8mm

4.0mm	14.0mm	19.7mm	6.1 - 6.0mm	4.4mm
5.0mm	14.0mm	14.6mm	4.0 - 3.9mm	3.7mm
6.0mm	14.0mm	14.1mm	6.9 - 6.8mm	4.5mm
8.0mm	14.0mm	12.3mm	8.8 - 8.6mm	3.7mm
10.0mm	14.0mm	17.0mm	6.6 - 6.3mm	3.7mm
12.5mm	15.0mm	22.9mm	10.1 - 9.7mm	4.8mm
17.5mm	14.0mm	20.7mm	5.8 - 4.9mm	7.6mm
25.0mm	18.0mm	30.0mm	8.5 - 6.5mm	11.5mm
35.0mm	18.0mm	29.5mm	18.72 - 14.0mm	14.5mm

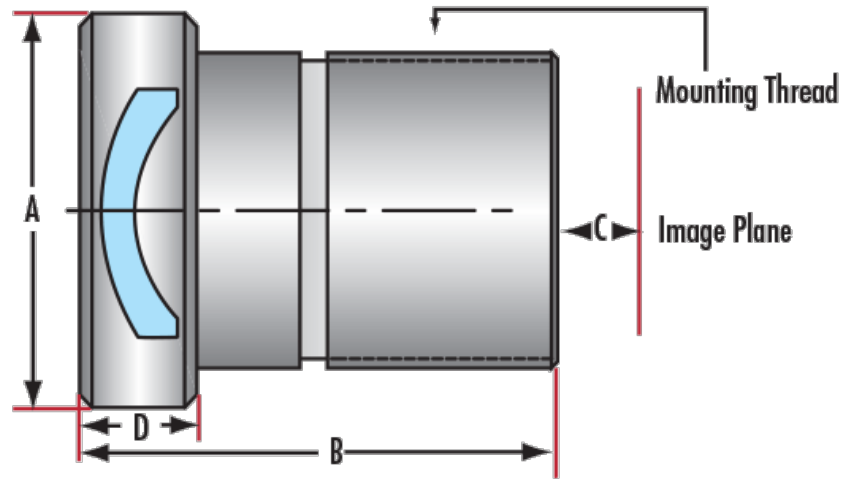

*Specified for Optimized Working Distance of 150 - 250mm.