

TECHSPEC® 25.4mm Length, M6 Thread, Post Holder



Stock #58-970 **5 In Stock**

- 1 + MRP ₹1,362

Price inclusive of all taxes

ADD TO CART

Volume Pricing	
Qty 1-9	₹1,362 each
Qty 10+	₹1,312 each
Need More?	Request Quote

Product Downloads

General

Metric Type:

Physical & Mechanical Properties

25.40 Length (mm):

Optical Properties

Substrate:

Threading & Mounting

Mounting Threads:
M6 x 1.0

Regulatory Compliance

RoHS 2015:
[Compliant](#)

Reach 224:
[Compliant](#)

Certificate of Conformance:
[View](#)

Country of Origin:
China

Imported By:
Edmund Optics India Private Limited
267, Greystone Building, Second Floor,
6th Cross Rd, Binnamangala,
Stage 1, Indiranagar, Bengaluru,
Karnataka, India 560038
Phone: +91- 80-6845 0000

Product Details

- English & Metric Post Holders
- English: 1/4-20 Base
- Metric: M6x1 Base
- Unique 3-Point Contact Design
- Aluminum with Brass Inserts

Post Holders have a unique 3-point contact design that inherently centers our [Stainless Steel Optical Mounting Posts](#) more accurately. The three contact pads run the entire inside length of each holder, thus ensuring a more accurate fit with our Posts. Additionally, three tapped holes allow thumbscrew orientation without removing the Post Holder from the breadboard table, base plate, or other fixture. Post hole depth is Post Holder length less 0.25" (6.35mm). Thread values are laser engraved on each Post Holder for quick integration. Locking thumbscrew included.

Technical Information

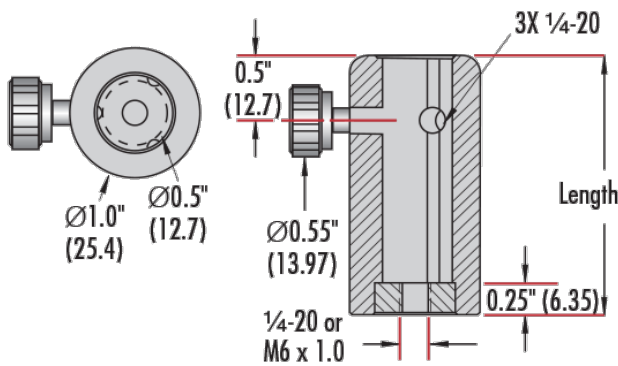

Description	Qty	Stock No.
Post Holder, 1" Length	1	#58-976
Post Holder, 1.5" Length	1	#58-977
Post Holder, 2" Length	2	#58-978
Post Holder, 3" Length	2	#58-979
Post Holder, 4" Length	1	#58-980
Post Holder, 6" Length	1	#58-981

Description	Qty	Stock No.
Post Holder, 25.4mm Length	1	#58-970
Post Holder, 38.1mm Length	1	#58-971
Post Holder, 50.8mm Length	2	#58-972
Post Holder, 76.2mm Length	2	#58-973
Post Holder, 101.6mm Length	1	#58-974
Post Holder, 152.4mm Length	1	#58-975