

TECHSPEC® 25.4mm Dia. x 500mm FL, 532nm Coated, Laser Grade PCX Lens



TECHSPEC Laser Grade PCXLenses

Stock **#38-705 4 In Stock**

[Other Coating Options](#)

1 MRP ₹23,306

Price inclusive of all taxes

ADD TO CART

Volume Pricing	
Qty 1-5	₹23,306 each
Qty 6-25	₹18,665 each
Qty 26-49	₹17,051 each
Need More?	Request Quote

Product Downloads

General

Plano-Convex Lens **Type:**

Physical & Mechanical Properties

25.40 +0.00/-0.025 **Diameter (mm):**

<3	Centering (arcmin):
4.00 ±0.10	Center Thickness CT (mm):
3.63	Edge Thickness ET (mm):
21.59	Clear Aperture CA (mm):
Protective as needed	Bevel:

Optical Properties

500.00 @ 355nm	Effective Focal Length EFL (mm):
497.44	Back Focal Length BFL (mm):
Laser V-Coat (532nm)	Coating:
R _{abs} <0.25% @ 532nm	Coating Specification:
Fused Silica (Corning 7980)	Substrate: <input type="checkbox"/>
10-5	Surface Quality:
λ	Power (P-V) @ 632.8nm:
λ/10	Irregularity (P-V) @ 632.8nm:
±1	Focal Length Tolerance (%):
238.04	Radius R₁ (mm):
19.69	f#:
0.03	Numerical Aperture NA:
532	Design Wavelength DWL (nm):
10 J/cm ² @ 532nm, 20ns, 20Hz	Damage Threshold, By Design: <input type="checkbox"/>

Regulatory Compliance

Compliant	RoHS 2015:
Compliant	Reach 209:
View	Certificate of Conformance:
Singapore	Country of Origin:
Edmund Optics India Private Limited 267, Greystone Building, Second Floor, 6th Cross Rd, Binnamangala, Stage 1, Indiranagar, Bengaluru, Karnataka, India 560038 Phone: +91-80-6845 0000	Imported By:

Need different specs or modifications?

Edmund Optics offers comprehensive custom manufacturing services for optical and imaging components tailored to your specific application requirements. Whether in the prototyping phase or preparing for full-scale production, we provide flexible solutions to meet your needs. Our experienced engineers are here to assist—from concept to completion.

Our capabilities include:

- Custom dimensions, materials, coatings, and more
- High-precision surface quality and flatness
- Tight tolerances and complex geometries
- Scalable production—from prototype to volume

Learn more about our [custom manufacturing capabilities](#) or submit an inquiry [here](#).

Product Details

- Guaranteed Laser Damage Threshold
- 10-5 Surface Quality
- λ/10 Surface Accuracy

TECHSPEC® Laser Grade PCXLenses are designed for high energy Nd:YAG laser applications including laser cutting, machining, and welding. The precision fused silica substrate, featuring λ/10 surface accuracy and 10-5 surface



Technical Information

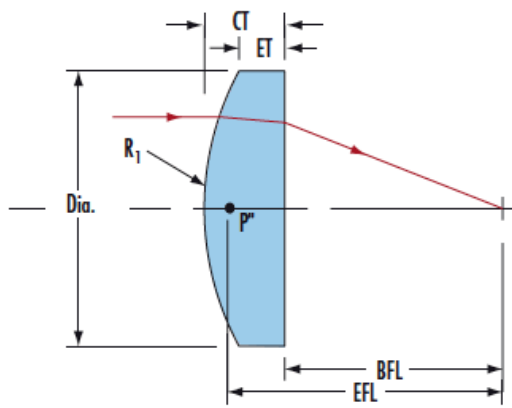

Compatible Mounts