

[See all 46 Products in Family](#)

## 25.4mm Dia, 650 - 1100nm, $\lambda/2$ Achromatic Waveplate



Achromatic Waveplates (Retarders)

Stock #39-045 **3 In Stock**

1  MRP ₹1,16,024

Price inclusive of all taxes

**ADD TO CART**

### Volume Pricing

Qty 1-5	₹1,16,024 each
Qty 6+	₹1,00,890 each
Need More?	<a href="#">Request Quote</a>

### Product Downloads

### General

Achromatic Waveplate **Type:**  
Air Spaced **Configuration:**

### Physical & Mechanical Properties

>20.0 **Clear Aperture CA (mm):**

25.40	<b>Diameter (mm):</b>
6.00 ±0.2	<b>Thickness (mm):</b>
+0/-0.25	<b>Dimensional Tolerance (mm):</b>
Crystalline	<b>Construction:</b>
<10	<b>Parallelism (arcsec):</b>
+0/-0.25	<b>Housing Tolerance (mm):</b>

## Optical Properties

R <sub>avg</sub> <0.75% @ 650 - 1100nm	<b>Coating:</b>
Crystal Quartz and MgF <sub>2</sub>	<b>Substrate:</b> <input type="checkbox"/>
λ/2	<b>Retardance:</b>
40-20	<b>Surface Quality:</b>
<λ/4 @ 632nm	<b>Transmitted Wavefront, P-V:</b>
λ/100 @ 20°C	<b>Retardance Tolerance:</b>
R <sub>avg</sub> <0.75% @ 650 - 1100nm	<b>Coating Specification:</b>
650 - 1100	<b>Wavelength Range (nm):</b>
>5 J/cm <sup>2</sup> @ 1064nm, 10ns, 10Hz	<b>Damage Threshold, By Design:</b> <input type="checkbox"/>

## Regulatory Compliance

<a href="#">Compliant</a>	<b>RoHS 2015:</b>
<a href="#">View</a>	<b>Certificate of Conformance:</b>
<a href="#">Compliant</a>	<b>Reach 247:</b>
China	<b>Country of Origin:</b>
Edmund Optics India Private Limited 267, Greystone Building, Second Floor, 6th Cross Rd, Binnamangala, Stage 1, Indiranagar, Bengaluru, Karnataka, India 560038 Phone: +91- 80-6845 0000	<b>Imported By:</b>

## Product Details

- Multiple Wavelength Ranges Available
- Flat Response Over Each Broad Spectral Range
- λ/4 and λ/2 Retardance
- Mounted in Black Anodized Aluminum Housing

Achromatic Waveplates (Retarders) provide a constant phase shift independent of the wavelength of light that is used. This wavelength independence is achieved by using two different birefringent crystalline materials. The relative shifts in retardation over the wavelength range are balanced between the two materials used. Achromatic Waveplates (Retarders), with their flat response, are ideal for use with tunable lasers, multiple laser line systems, and other broad-spectrum sources.

Designed to be used at an angle of incidence of 0°, changes of ±3° will yield less than 1% change in retardance. The 23mm clear aperture waveplates will feature a cemented construction. All Achromatic Waveplates (Retarders) are mounted in an anodized aluminum housing with the fast axis clearly indicated.

## Technical Information

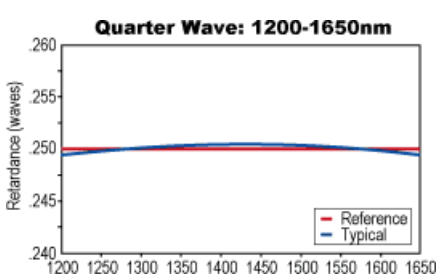

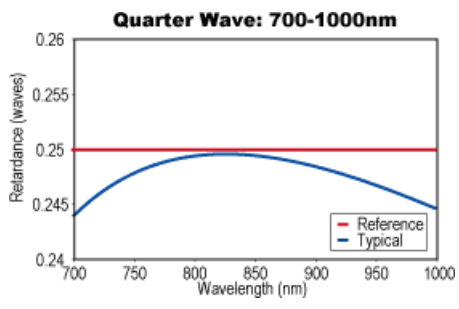

**25.4mm Diameter Waveplates**

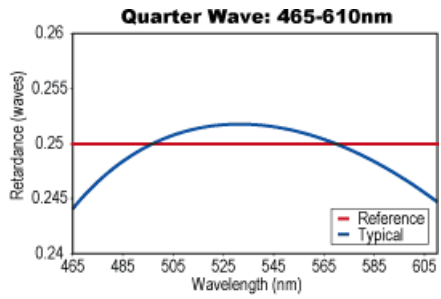
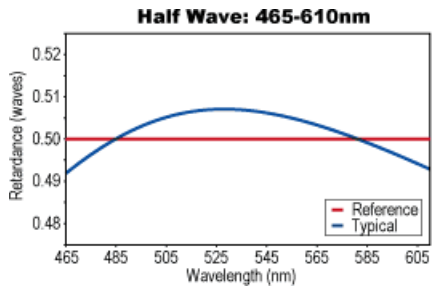
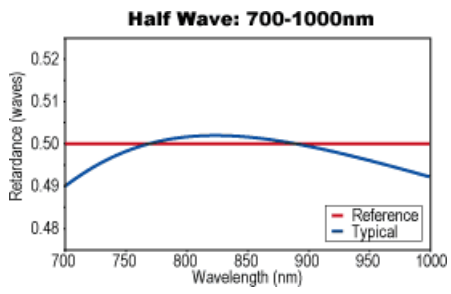
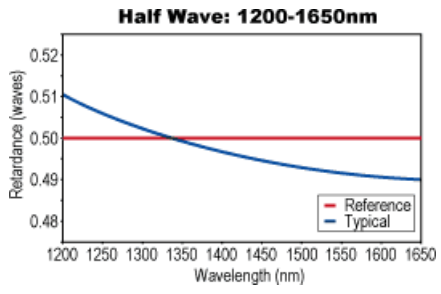
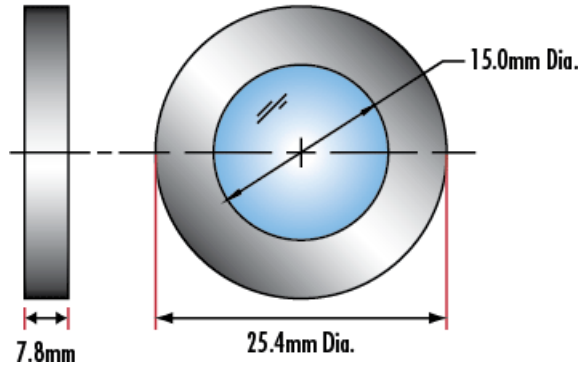

**30.0mm Diameter Waveplates**

