

[See all 54 Products in Family](#)

TECHSPEC® 15° Beam Dev. 12.5mm Dia. VIS-NIR, N-BK7 Wedge Prism



Stock #35-802 **5 In Stock**

- 1 + MRP ₹5,801

i Price inclusive of all taxes

ADD TO CART

Volume Pricing	
Qty 1-5	₹5,801 each
Qty 6-25	₹4,616 each
Qty 26-49	₹4,364 each
Need More?	Request Quote

Product Downloads

General

Wedge Prism **Type:**

Note:
Specify this is S1 & S2 power and irregularity, not the overall power of the wedge

Physical & Mechanical Properties

Diameter (mm):

12.50 +0.00/-0.10

Thickness (mm):

1.50

Bevel:

Protective as needed

Wedge Angle (arcmin):

25° 14'

Optical Properties

Angle Tolerance (arcsec):

±30

Coating:

VIS-NIR (400-1000nm)

Design Wavelength DWL (nm):

632.8

Substrate:

[N-BK7](#)

Surface Quality:

20-10

Image Orientation:

Beam Deviation

Coating Specification:

R_{abs} ≤0.25% @ 880nm
R_{avg} ≤1.25% @ 400 - 870nm
R_{avg} ≤1.25% @ 890 - 1000nm

Wavelength Range (nm):

400 - 1000

Power (fringes) @ 632.8nm:

0.50

Irregularity (fringes) @ 632.8nm:

0.20

Ray Deviation @ 633nm (°):

15.00

Power (diopters):

26.79

Wedge Angle (°):

25.23°

Material Properties

Coefficient of Thermal Expansion CTE (10⁻⁶/°C):

7.1

Regulatory Compliance

RoHS 2015:

[Compliant](#)

Certificate of Conformance:

[View](#)

Reach 235:

[Compliant](#)

Country of Origin:

Singapore

Imported By:

Edmund Optics India Private Limited
267, Greystone Building, Second Floor,
6th Cross Rd, Binnamangala,
Stage 1, Indiranagar, Bengaluru,
Karnataka, India 560038
Phone: +91- 80-6845 0000

Need different specs or modifications?

Edmund Optics offers comprehensive custom manufacturing services for optical and imaging components tailored to your specific application requirements. Whether in the prototyping phase or preparing for full-scale production, we provide flexible solutions to meet your needs. Our experienced engineers are here to assist—from concept to completion.

Our capabilities include:

- Custom dimensions, materials, coatings, and more
- High-precision surface quality and flatness
- Tight tolerances and complex geometries
- Scalable production—from prototype to volume

Learn more about our [custom manufacturing capabilities](#) or submit an inquiry [here](#).

Product Details

- Ideal for Beam Steering
- 0.5° - 15° Beam Deviation Options
- Available Uncoated or Anti-Reflection Coated
- [Anamorphic Prism Pair](#) Also Available

Wedge prisms can be used individually to deviate a laser beam a set angle, or two wedge prisms can be used together for beam steering applications. A single wedge prism's ability to deviate the angle of an incident beam is measured in Diopters with 1 diopter deviating the beam 1cm at a 1m working distance.

Two wedge prisms can be used as an anamorphic pair for beam shaping (to correct the elliptical shape of diode outputs). Wedge prisms can also be paired to steer a beam anywhere within a circle described by the full angle 4θ , where θ is the deviation from a single prism. This beam steering is accomplished by rotating the two wedge prisms independently of each other and is typically used to scan a beam to different locations in imaging applications.

Note: Beam deviation is shown in degrees and diopters. One diopter is 1cm of deviation at a distance of 1m from the prism.



Technical Information

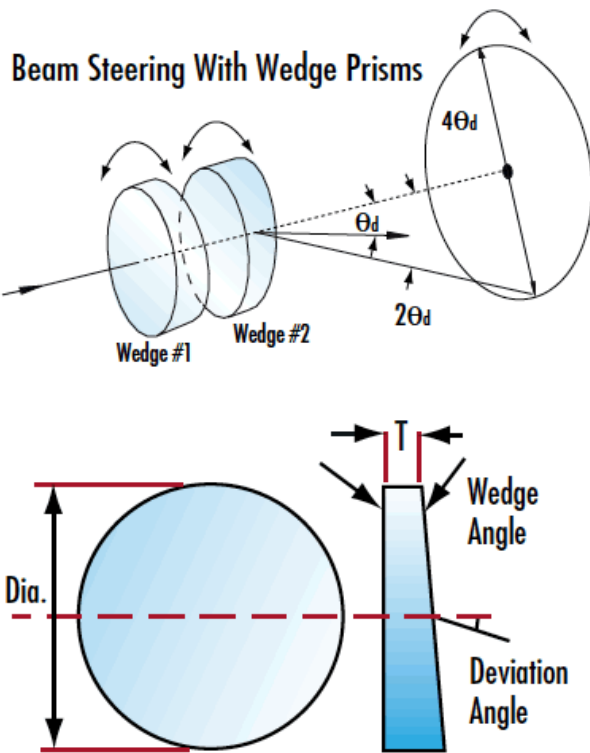

N-BK7

Uncoated N-BK7 Typical Transmission

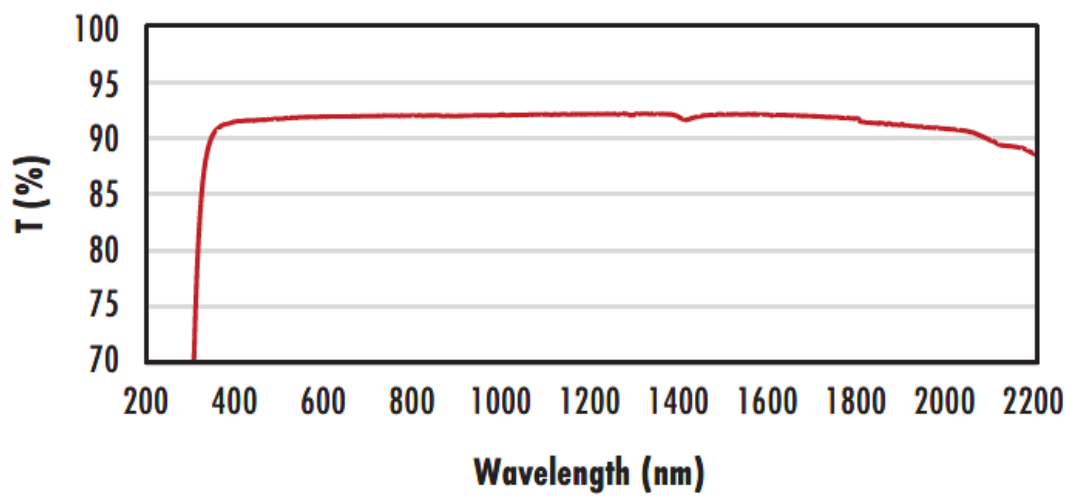

Typical transmission of a 3mm thick, uncoated N-BK7 window across the UV - NIR spectra.

[Click Here to Download Data](#)

N-BK7 with MgF₂ Coating Typical Transmission

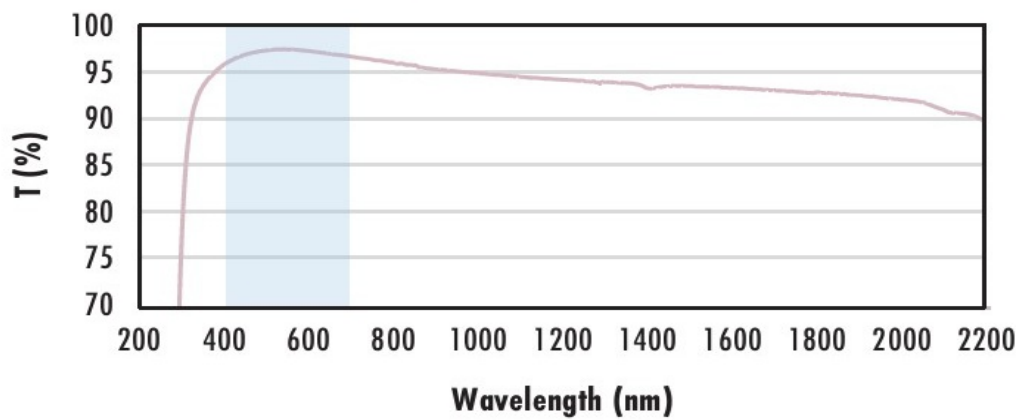

Typical transmission of a 3mm thick N-BK7 window with MgF₂ (400-700nm) coating at 0° AOI.

The blue shaded region indicates the coating design wavelength range, with the following specification:

$R_{avg} \leq 1.75\%$ @ 400 - 700nm (N-BK7)

Data outside this range is not guaranteed and is for reference only.

[Click Here to Download Data](#)

N-BK7 with VIS-EXT Coating Typical Transmission

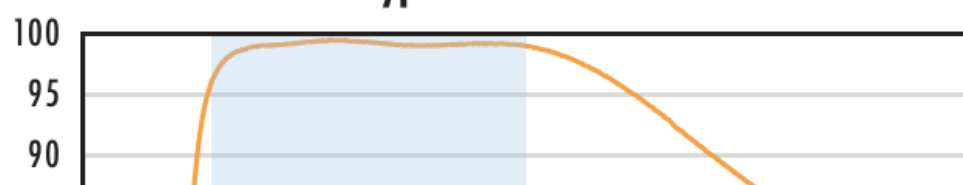

Typical transmission of a 3mm thick N-BK7 window with VIS-EXT (350-700nm) coating at 0° AOI.

The blue shaded region indicates the coating design wavelength range, with the following specification:

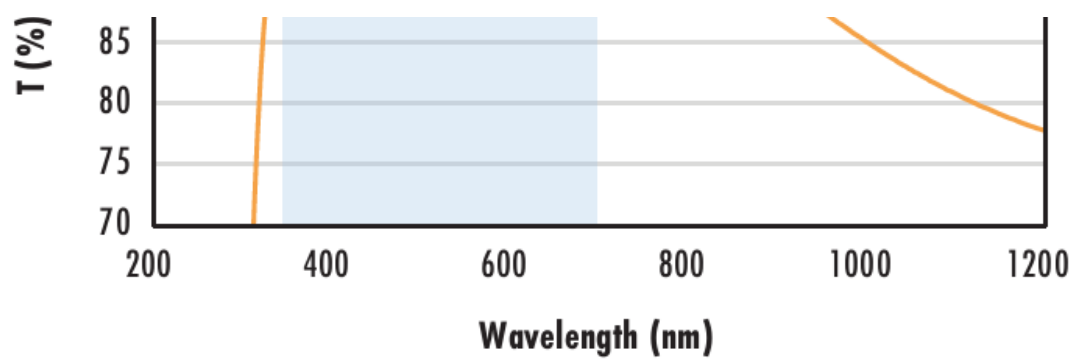

wavelength range, with the following specification:
 $R_{avg} \leq 0.5\% @ 350 - 700nm$
 Data outside this range is not guaranteed and is for reference only.
[Click Here to Download Data](#)

**N-BK7 with VIS-NIR Coating
 Typical Transmission**

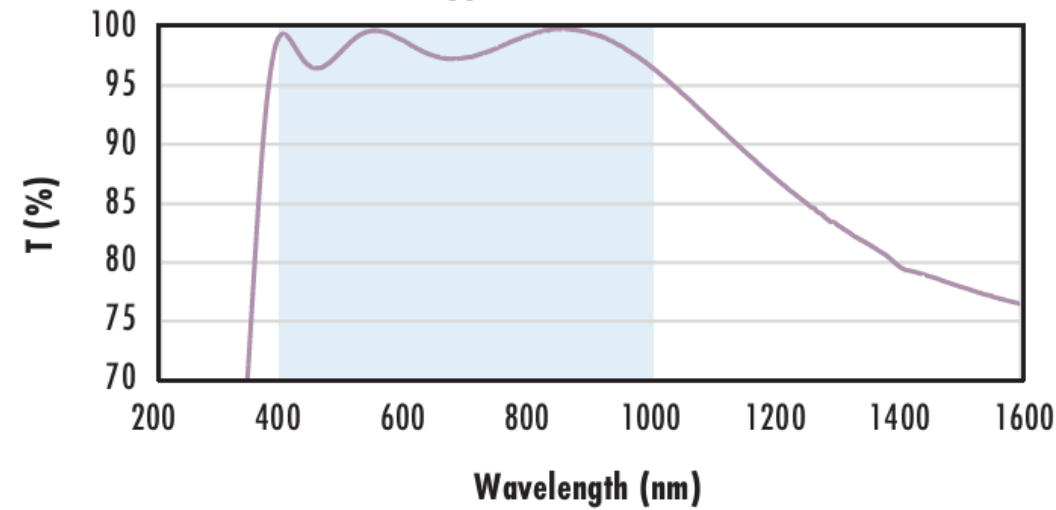

Typical transmission of a 3mm thick N-BK7 window with VIS-NIR (400-1000nm) coating at 0° AOI.
 The blue shaded region indicates the coating design wavelength range, with the following specification:
 $R_{abs} \leq 0.25\% @ 880nm$
 $R_{avg} \leq 1.25\% @ 400 - 870nm$
 $R_{avg} \leq 1.25\% @ 890 - 1000nm$
 Data outside this range is not guaranteed and is for reference only.
[Click Here to Download Data](#)

**N-BK7 with VIS 0° Coating
 Typical Transmission**

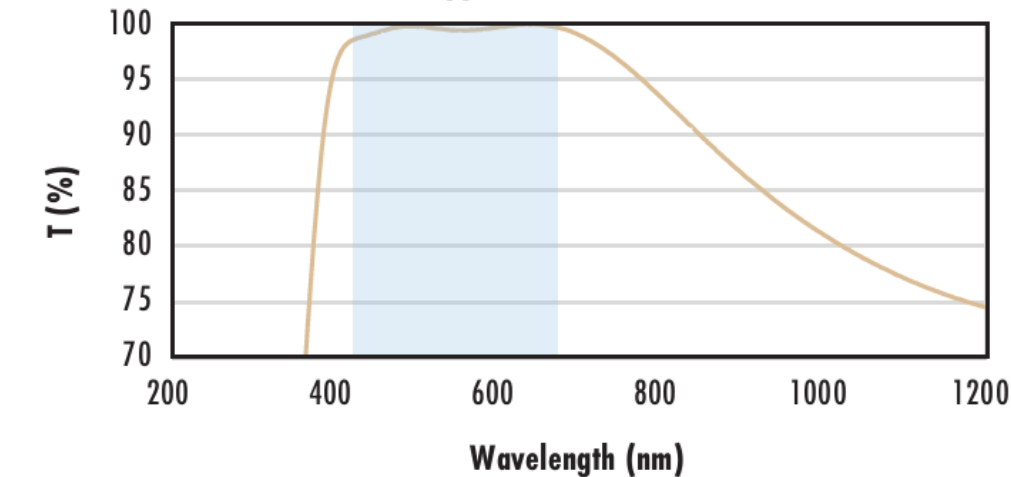

Typical transmission of a 3mm thick N-BK7 window with VIS 0° (425-675nm) coating at 0° AOI.
 The blue shaded region indicates the coating design wavelength range, with the following specification:
 $R_{avg} \leq 0.4\% @ 425 - 675nm$
 Data outside this range is not guaranteed and is for reference only.
[Click Here to Download Data](#)

**N-BK7 with YAG-BBAR Coating
 Typical Transmission**

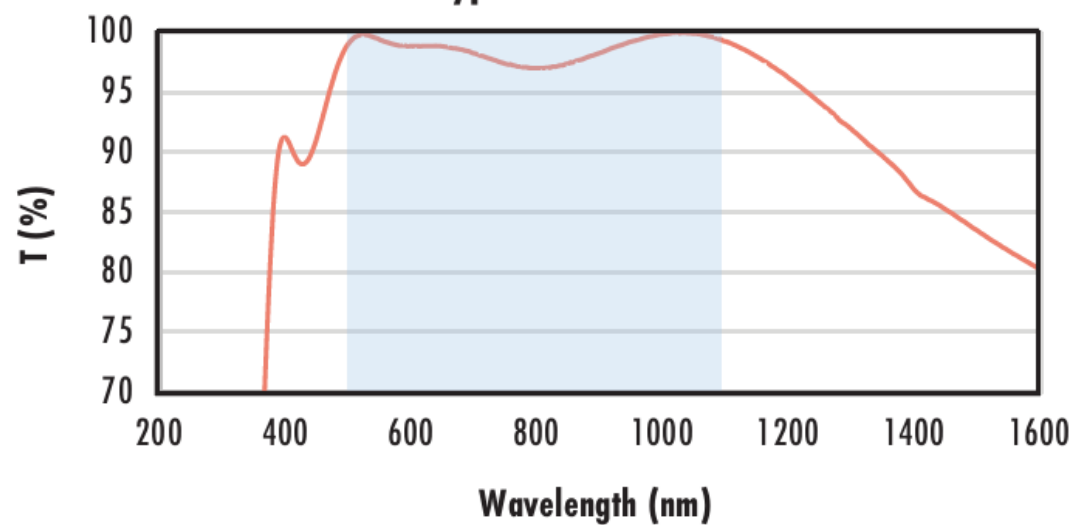

Typical transmission of a 3mm thick N-BK7 window with YAG-BBAR (500-1100nm) coating at 0° AOI.
 The blue shaded region indicates the coating design wavelength range, with the following specification:
 $R_{abs} \leq 0.25\% @ 532nm$
 $R_{abs} \leq 0.25\% @ 1064nm$
 $R_{avg} \leq 1.0\% @ 500 - 1100nm$
 Data outside this range is not guaranteed and is for reference only.
[Click Here to Download Data](#)

**N-BK7 with NIR I Coating
 Typical Transmission**

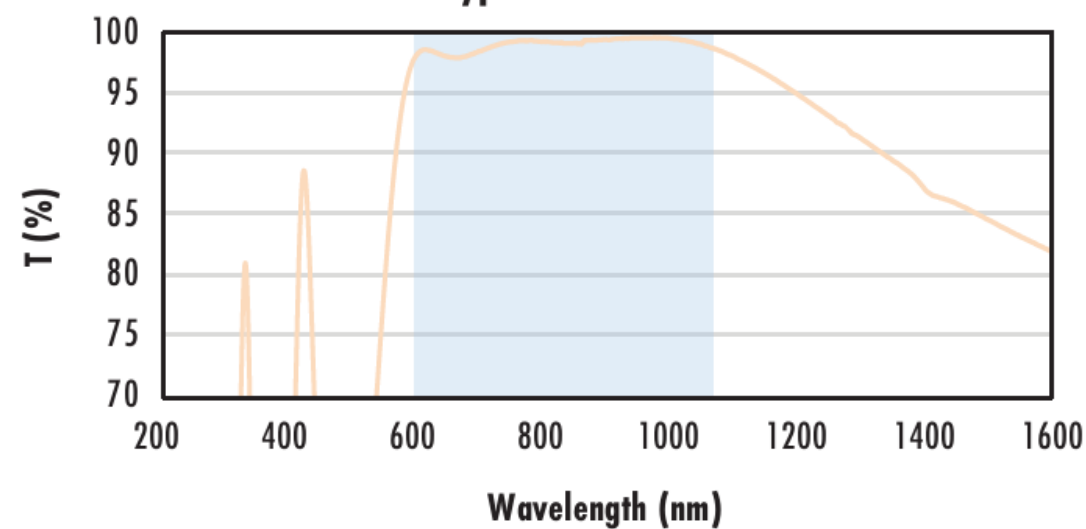

Typical transmission of a 3mm thick N-BK7 window with NIR I (600 - 1050nm) coating at 0° AOI.
 The blue shaded region indicates the coating design wavelength range, with the following specification:
 $R_{avg} \leq 0.5\% @ 600 - 1050nm$
 Data outside this range is not guaranteed and is for reference only.
[Click Here to Download Data](#)

N-BK7 with NIR II Coating Typical Transmission

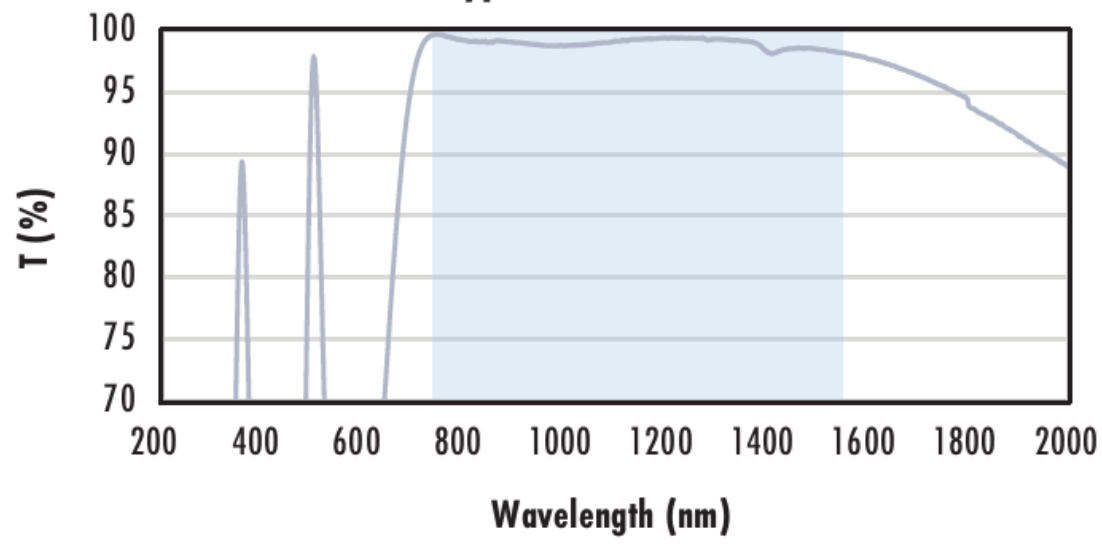

Typical transmission of a 3mm thick N-BK7 window with NIR II (750 - 1550nm) coating at 0° AOI.

The blue shaded region indicates the coating design wavelength range, with the following specification:

- $R_{abs} \leq 1.5\%$ @ 750 - 800nm
- $R_{abs} \leq 1.0\%$ @ 800 - 1550nm
- $R_{avg} \leq 0.7\%$ @ 750 - 1550nm

Data outside this range is not guaranteed and is for reference only.

[Click Here to Download Data](#)

Coating Curves