

[See all 49 Products in Family](#)

TECHSPEC® 15.25mm Optical Axis Offset Prism Adapter for 22mm Dia. Lens



Optical Axis Offset Prism Adapter



Stock #11-125 **1 In Stock**

- 1 + MRP ₹40,144

Price inclusive of all taxes

ADD TO CART

Volume Pricing	
Qty 1+	₹40,144 each
Need More?	Request Quote

Product Downloads

General

Edmund Optics® **Manufacturer:**

Lens Accessory **Type:**

22 **Compatible Telecentric Lens Diameter (mm):**

Regulatory Compliance

Certificate of Conformance:

[View](#)

Singapore

Country of Origin:

Imported By:

Edmund Optics India Private Limited
267, Greystone Building, Second Floor,
6th Cross Rd, Binnamangala,
Stage 1, Indiranagar, Bengaluru,
Karnataka, India 560038
Phone: +91- 80-6845 0000

Product Details

- 2/3", C-Mount Telecentric Lens
- Up to 2.3 MegaPixels, 4.5 μ m Pixel Size Sensors
- Small Telecentric Lens with Coaxial Illumination Options

TECHSPEC® CompactTL™ Telecentric Lenses are designed for applications with tight space constraints due to their ultra-compact design. These lenses feature a 2/3" sensor format and a variety of different working distance and magnification options. From single unit to high volume implementation, these lenses provide a great price to performance ratio. TECHSPEC® CompactTL™ Telecentric Lenses are perfect for integration into gauging systems due to their excellent telecentricity and low distortion. The fixed iris and lockable focus make these lenses ideal for implementation into factory floors and assembly lines, as they will remain fixed over time.

Technical Information

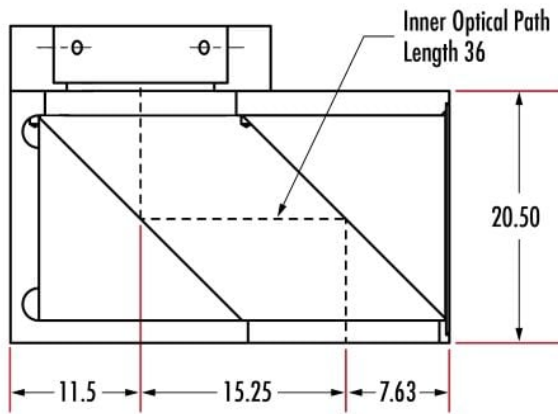

15.25mm Optical Axis Offset Prism Adapter (Units: mm)