

[See all 46 Products in Family](#)

12.7mm Dia, 450 - 650nm, $\lambda/4$ Achromatic Waveplate



Achromatic Waveplates (Retarders)

Stock #39-030 **1 In Stock**

⊖ 1 ⊕ MRP ₹90,801

● Price inclusive of all taxes

ADD TO CART

Volume Pricing

Qty 1-5	₹90,801 each
Qty 6+	₹77,181 each
Need More?	Request Quote

Product Downloads

General

Achromatic Waveplate **Type:**
Air Spaced **Configuration:**

Physical & Mechanical Properties

>8.0 **Clear Aperture CA (mm):**

12.70	Diameter (mm):
6.00 ±0.2	Thickness (mm):
+0/-0.25	Dimensional Tolerance (mm):
Crystalline	Construction:
<10	Parallelism (arcsec):
+0/-0.25	Housing Tolerance (mm):

Optical Properties

R _{avg} <0.75% @450 - 650nm	Coating:
Crystal Quartz and MgF ₂	Substrate: <input type="checkbox"/>
λ/4	Retardance:
40-20	Surface Quality:
<λ/4 @632nm	Transmitted Wavefront, P-V:
λ/100 @20°C	Retardance Tolerance:
R _{avg} <0.75% @450 - 650nm	Coating Specification:
450 - 650	Wavelength Range (nm):
>5 J/cm ² @ 1064nm, 10ns, 10Hz	Damage Threshold, By Design: <input type="checkbox"/>

Regulatory Compliance

Compliant	RoHS 2015:
View	Certificate of Conformance:
Compliant	Reach 247:
China	Country of Origin:
Edmund Optics India Private Limited 267, Greystone Building, Second Floor, 6th Cross Rd, Binnamangala, Stage 1, Indiranagar, Bengaluru, Karnataka, India 560038 Phone: +91- 80-6845 0000	Imported By:

Product Details

- Multiple Wavelength Ranges Available
- Flat Response Over Each Broad Spectral Range
- λ/4 and λ/2 Retardance
- Mounted in Black Anodized Aluminum Housing

Achromatic Waveplates (Retarders) provide a constant phase shift independent of the wavelength of light that is used. This wavelength independence is achieved by using two different birefringent crystalline materials. The relative shifts in retardation over the wavelength range are balanced between the two materials used. Achromatic Waveplates (Retarders), with their flat response, are ideal for use with tunable lasers, multiple laser line systems, and other broad-spectrum sources.

Designed to be used at an angle of incidence of 0°, changes of ±3° will yield less than 1% change in retardance. The 23mm clear aperture waveplates will feature a cemented construction. All Achromatic Waveplates (Retarders) are mounted in an anodized aluminum housing with the fast axis clearly indicated.

Technical Information

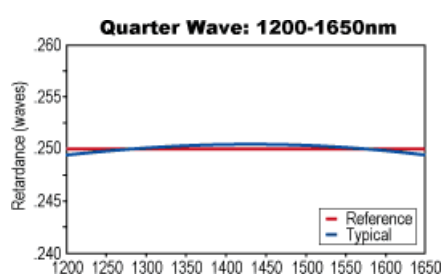

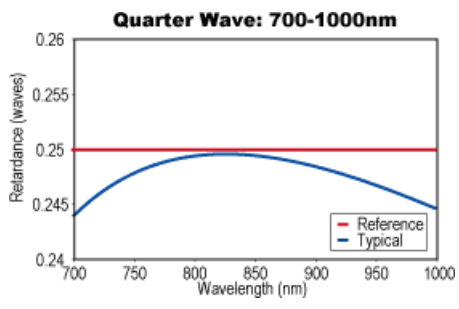

25.4mm Diameter Waveplates

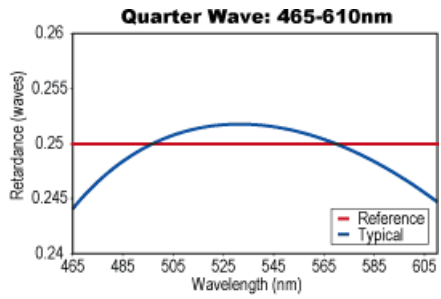
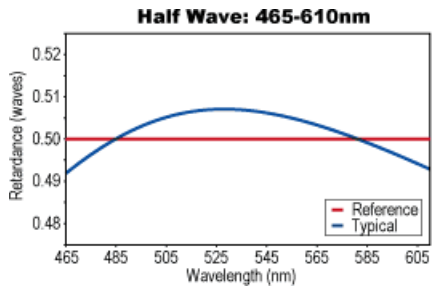
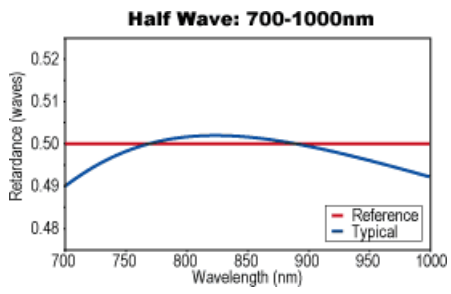
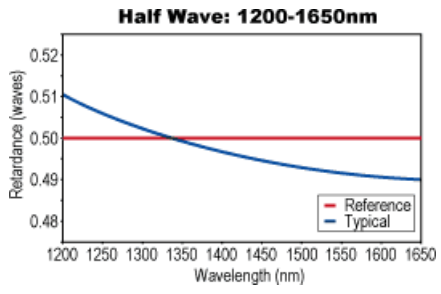
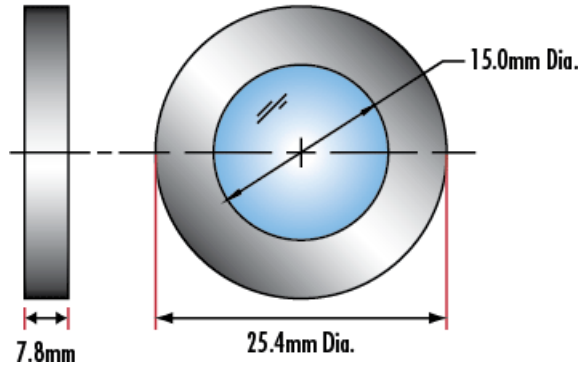

30.0mm Diameter Waveplates

