

[See all 34 Products in Family](#)

TECHSPEC® 1:1.5 with 40mm and 60mm EFL Achromats, 15mm Achromatic Pair



TECHSPEC Mounted Achromatic Lens Pairs

Stock **#46-001** **2 In Stock**

⊖ 1 ⊕ MRP ₹21,087

● Price inclusive of all taxes

ADD TO CART

Volume Pricing	
Qty 1-5	₹21,087 each
Qty 6-25	₹16,849 each
Qty 26-49	₹16,244 each
Need More?	Request Quote

Product Downloads

General

Relay Lens **Type:**

Physical & Mechanical Properties

9.5 **Clear Aperture CA (mm):**

Center Air Spacing (mm):

2.97

Housing Diameter (mm):
15 +0.0/-0.10

Housing Length (mm):
21 ±0.2

Lens Edge Spacing at Mount (mm):
4

Image Distance (mm):
53.55

Construction:
Achromat Pair in Anodized Aluminum Housing

Optical Properties

Substrate:
N-BK7 / N-SF5 / N-BK7 / N-SF5

Surface Quality:
40-20

Working f#:
f/6.34

Coating:
MgF₂ (400-700nm)

Coating Specification:
R_{avg} ≤ 1.75% @ 400 - 700nm

Effective Focal Length EFL A (mm):
40.00

Effective Focal Length EFL B (mm):
60.00

Magnification:
1:1.5

Object Distance (mm):
33.30

Wavelength Range (nm):
400 - 700

Regulatory Compliance

RoHS 2015:
Compliant

Reach 209:
Compliant

Certificate of Conformance:
View

Country of Origin:
United States

Imported By:
Edmund Optics India Private Limited
267, Greystone Building, Second Floor,
6th Cross Rd, Binnamangala,
Stage 1, Indiranagar, Bengaluru,
Karnataka, India 560038
Phone: +91- 80-6845 0000

Product Details

- 15mm and 30mm Diameter Options
- AR Coated Lenses
- Mounted Achromatic Pairs Kits Available

TECHSPEC® Mounted Achromatic Lens Pairs combine popular TECHSPEC® Achromats into common configurations used for relay and projection applications. Packaged in slim-line aluminum housing, each pair is ready for integration into a host of OEM applications, eliminating the need to handle loose optics. 15.0mm pairs can be coupled into C-mount components using [Helicoid Barrel Accessory](#). TECHSPEC Mounted Achromatic Lens Pairs have also been oriented for optimum system performance. All lenses, 15.0mm and 30.0mm, are AR coated. Lower f# pairs may not be ideal for imaging applications depending on the performance requirements. Cylinder lenses can be incorporated into empty barrels in order to generate lines or sheets of light.

Technical Information

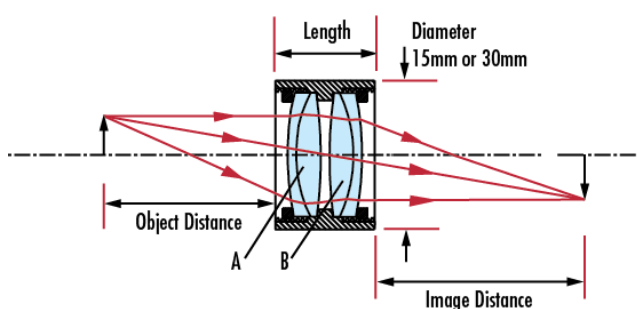

Coating Curves
