

**TECHSPEC® 10mm FL f/4, Blue Series M12 Lens**



10mm FL Blue Series M12 Lens



Stock **#69-263** [CONTACT US](#)

MRP ₹9,027

Price inclusive of all taxes

**ADD TO CART**

Volume Pricing	
Qty 1-49	₹9,027 each
Qty 50+	₹7,143 each
Need More?	<a href="#">Request Quote</a>

Product Downloads

**General**

Blue Series **Product Family:**

M12 Imaging Lens **Type:**

No **IR Cut Filter:**

Imaging Lens Type:  
High Performance M12 Lens

## Physical & Mechanical Properties

Fixed Iris Option:  
17.00 Length (mm):  
14 Maximum Diameter (mm):  
14 Outer Diameter (mm):  
5 Weight (g):

## Optical Properties

Horizontal Field of View @ Max Sensor Format:  
27.1°

Field of View at Max Sensor Format:  
Horizontal: 71.8mm - 27.1°  
Vertical: 53.8mm - 20.5°  
Diagonal: 89.9mm - 33.6°

Horizontal Field of View, 1/3" Sensor:  
71.8mm - 27.1°

Horizontal Field of View, 1/4" Sensor:  
53.8mm - 20.5°

6.00 Maximum Image Circle (mm):

0.0079 Numerical Aperture NA, Object Side:

5(4) Number of Elements (Groups):

400 - 700 Wavelength Range (nm):

10.00 Focal Length FL (mm):

150 - ∞ Working Distance (mm):

f/4 Aperture (f/#):

-0.25 @ Full Field Distortion (%):

6.6 - 6.3 Back Focal Length BFL (mm):

M4 MgF<sub>2</sub> @ 550nm Coating Specification:

8.45 Entrance Pupil Position (mm):

8.24 Object Space Principal Plane (mm):

-3.29 Image Space Principal Plane (mm):

-0.25 Maximum Distortion (%):

-3.08 Exit Pupil Position (mm):

VIS Lens Wavelength Range:

## Sensor

1/3" Maximum Sensor Format:

1.40 Pixel Size (µm):

## Threading & Mounting

N/A Filter Thread:

S-Mount (M12 x 0.5) Mount:

## Regulatory Compliance

Compliant RoHS 2015:

China

Edmund Optics India Private Limited  
 267, Greystone Building, Second Floor,  
 6th Cross Rd, Binnamangala,  
 Stage 1, Indiranagar, Bengaluru,  
 Karnataka, India 560038  
 Phone: +91- 80-6845 0000

## Product Details

- Up to 1/2", S-Mount Lens
- Up to 5 MegaPixels, 1.4µm Pixel Size Sensors
- High Resolution Board Camera Lens Optimized for Close WD
- 2mm to 35mm Focal Length
- **Ruggedized Designs** Also Available

TECHSPEC® Blue Series M12 Lenses feature high resolution performance, along with the same great versatility of our [TECHSPEC® Green Series M12 Lenses](#). Each lens consists of several precision glass elements mounted in a compact, aluminum housing. These lenses can connect to C-Mount cameras using the M12 x0.5 Adapter for C-Mount Cameras ([#53-675](#)) or the M12 x0.5 C-Mount Adapter with Rubber O-Ring ([#59-241](#)) for vibration-sensitive environments. TECHSPEC® Blue Series M12 Lenses are ideal for automotive, industrial, and medical imaging application. Prescription data is available by submitting a [Request for Prescription Form](#).

**Note:** Compatible [TECHSPEC® M12 Imaging Lens Accessories](#) available.

Edmund Optics has created multiple product families of our TECHSPEC® M12 S-Mount Lenses, which are designed to provide high resolution. These high performance lenses feature precision glass designs in a metal housing and have optimized specifications between each product family to meet your application needs.

- Blue Series M12 Lenses: High resolution finite conjugate designs optimized for machine vision working distances.
- **Rugged Blue Series M12 Lenses:** Stabilized ruggedization versions of our Blue Series M12 Lenses, utilizing the same optics.
- **Green Series M12 Lenses:** Finite conjugate designs optimized for machine vision working distances.
- **Red Series M12 Lenses:** Infinite conjugate designs optimized for high resolution performance out to infinity.
- **HEO Series M12 Lenses:** Harsh Environment Optics (HEO) sealed versions of our Red Series M12 Lenses.
- **Liquid Lens M12 Lenses:** Integrated liquid lens for fast electronic focus.

## Technical Information

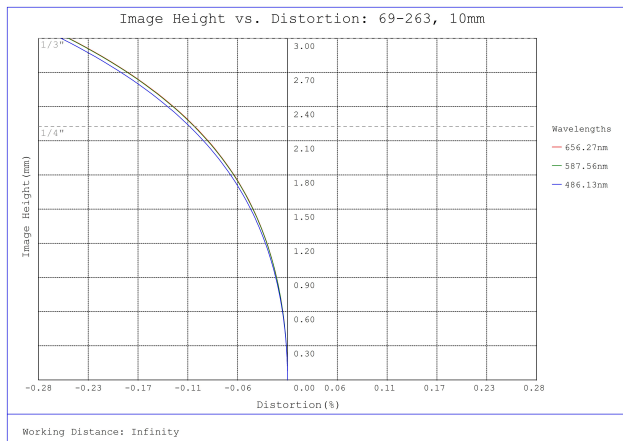

#69-263, 10mm FL f/4, Blue Series M12 Lens, Distortion Plot

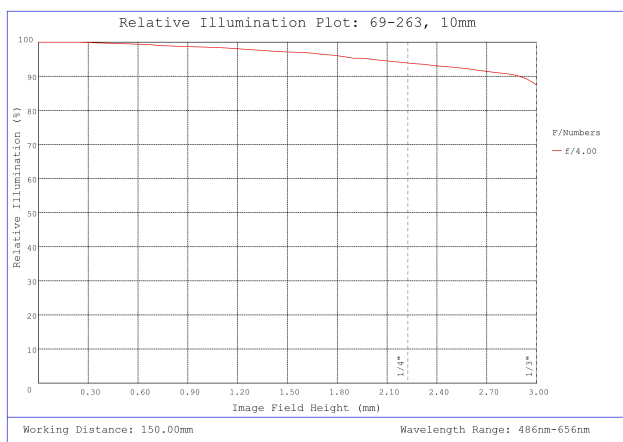

#69-263, 10mm FL f/4, Blue Series M12 Lens, Relative Illumination Plot

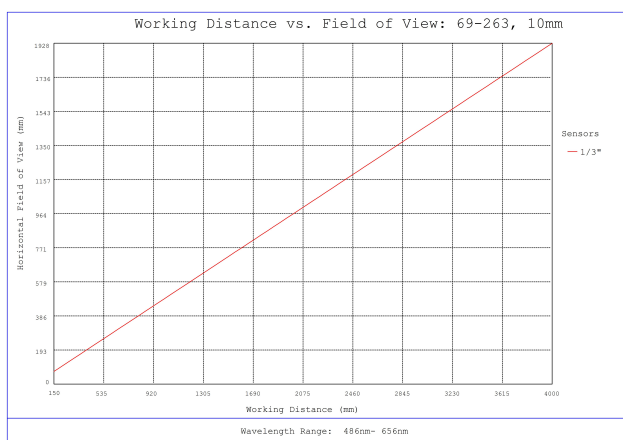

#69-263, 10mm FL f/4, Blue Series M12 Lens, Working Distance versus Field of View Plot

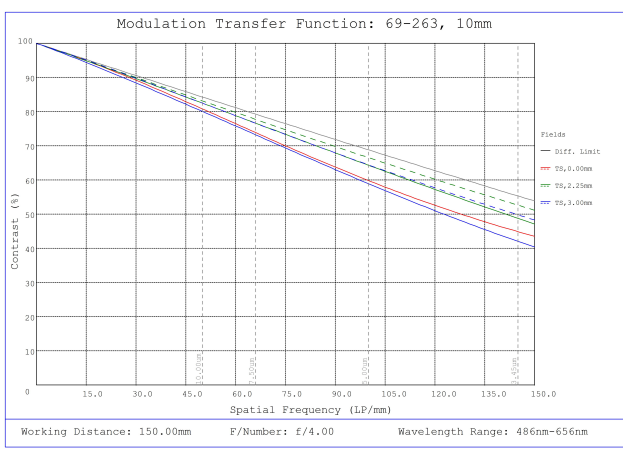

#69-263, 10mm FL f/4, Blue Series M12 Lens, Modulated Transfer Function (MTF) Plot, 150mm Working Distance, f4



#69-263, 10mm FL f/4, Blue Series M12 Lens, Depth of Field Plot, 150mm Working Distance, f4

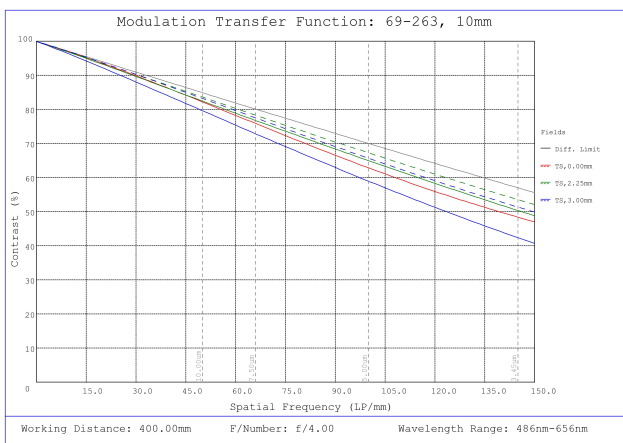

#69-263, 10mm FL f/4, Blue Series M12 Lens, Modulated Transfer Function (MTF) Plot, 400mm Working Distance, f4

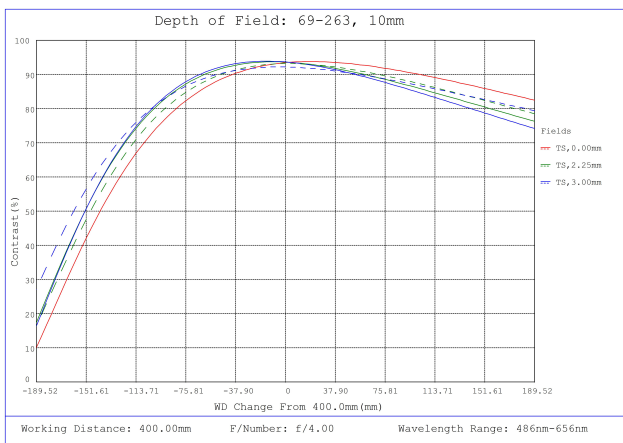

#69-263, 10mm FL f/4, Blue Series M12 Lens, Depth of Field Plot, 400mm Working Distance, f4

Focal Length	A	B	C*	D
2.0mm	18.0mm	21.7mm	2.26mm	4.75mm
3.0mm	14.0mm	17.1mm	4.8 - 4.7mm	5.8mm
4.0mm	14.0mm	19.7mm	6.1 - 6.0mm	4.4mm
5.0mm	14.0mm	14.6mm	4.0 - 3.9mm	3.7mm
6.0mm	14.0mm	14.1mm	6.9 - 6.8mm	4.5mm
8.0mm	14.0mm	12.3mm	8.8 - 8.6mm	3.7mm
10.0mm	14.0mm	17.0mm	6.6 - 6.3mm	3.7mm

12.5mm	15.0mm	22.9mm	10.1 - 9.7mm	4.8mm
17.5mm	14.0mm	20.7mm	5.8 - 4.9mm	7.6mm
25.0mm	18.0mm	30.0mm	8.5 - 6.5mm	11.5mm
35.0mm	18.0mm	29.5mm	18.72 - 14.0mm	14.5mm



\*Specified for Optimized Working Distance of 150 - 250mm.

;